

MULTISERVICE HOSPITALITY EQUIPMENT

Attrezzature complete per l'ospitalità





Carrelli e mobili di servizio in legno

WOOD TROLLEYS AND SERVICE FURNITURE
CHARIOTS ET MEUBLES DE SERVICE EN BOIS
WAGEN UND SERVICEMÖBEL AUS HOLZ

CA 9012R



CA 9012R

IT Carrelli Guéridon. Struttura portante in tubo di acciaio inox AISI 304 - ripiani in nobilitato con bordo in gomma - 2 ruote multidirezionali ø 95 mm.

EN Guéridon trolleys. Tubular stainless steel AISI 304 supporting structure - melamine shelves with rubber edges - 2 multidirectional wheels ø 95 mm.

FR Chariots Guéridon. Structure portante en tube d'acier inox AISI 304 - étagères en mélaminé avec bord en caoutchouc - 2 roues multidirectionnelles ø 95 mm.

DE Guéridon Wagen. Stützrahmen aus Edelstahlrohr AISI 304 - Regale aus Melamin mit Gummikante - 2 Mehrweg-Räder ø 95 mm.

	CA 9012R noce-walnut	CA 9012R CA carbon
	70 x 50 x 78(h) cm	
	2	
	40 Kg	
	340 €	

CA 901



CA 901 CA

IT Carrelli Guéridon. Struttura portante in tubo di acciaio inox AISI 304 - ripiani in nobilitato con bordo in gomma - 4 ruote multidirezionali ø 95 mm.

EN Guéridon trolleys. Tubular stainless steel supporting structure AISI 304 - melamine shelves with rubber edges - 4 multidirectional wheels ø 95 mm.

FR Chariots Guéridon. Structure portante en tube d'acier inox AISI 304 - étagères en mélaminé avec bord en caoutchouc - 4 roues multidirectionnelles ø 95 mm.

DE Guéridon Wagen. Stützrahmen aus Edelstahlrohr AISI 304 - Einlegeböden aus Melamin mit Gummikante - Wagen in den Farben Walnuss und Wenge erhältlich - 4 Mehrwegräder ø 95 mm.

	CA 901 noce-walnut	CA 901 CA carbon
	70 x 50 x 78(h) cm	
	2	
	40 Kg	
	360 €	

Carrelli Guéridon
Guéridon trolleys

CL 903

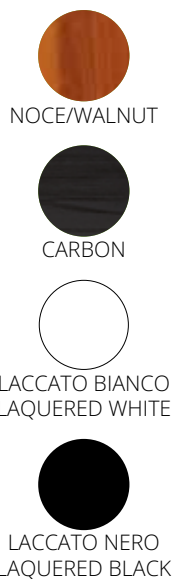

CL 903 B

IT Carrelli Guéridon. Struttura portante in legno massello - ripiani in nobilitato con bordo in gomma (escluso CL903B - CL903N) - ruote multidirezionali ø 95 mm.

EN Guéridon trolleys. Solid wood supporting structure - melamine shelves with rubber edges (not for CL903B - CL903N) - multidirectional wheels ø 95 mm.

FR Chariots Guéridon. Structure portante en bois massif - étagères en mélaminé avec bord en caoutchouc (à l'exclusion du code CL903B CL903N) - roues multidirectionnelles ø 95 mm.

DE Guéridon Wagen. Stützrahmen aus Massivholz- Einlegeböden aus Melamin mit Gummikante (ohne den Code CL903B - CL903N) - Mehrwegräder ø 95 mm.

Optional Carrelli Guéridon Guèridon Trolley optional

n. 4 ruote con cuffia ottonata o cromata
4 brass or chrome plated copper castors
4roulette à bille en laiton ou chromée
4 Messing- oder Chrom-Kugelrolle

160 €

i	CL 903 noce-walnut	CL 903 CA carbon	CL 903 B laccato bianco laquered white	CL 903 N laccato nero laquered black
cm	70 x 50 x 78(h) cm			
N.	2			
MAX Kg	40 Kg			
	360 €		580 €	

CLP 2002

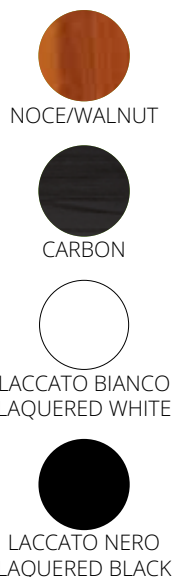

CLP 2002 N

IT Carrelli di servizio in legno. Struttura in legno massello - ripiani in multistrato di betulla - maniglie di spinta integrate nel piano superiore - ringhiere di contenimento sui piani inferiori - ruote multidirezionali ø 95 mm.

EN Wooden service trolleys. Solid wood structure - birch multi-layered wood shelves - integrated push handles in the upper shelf - retaining rails on the lower shelves - multidirectional wheels ø 95 mm.

FR Chariots de service en bois. Structure en bois massif - étagères en bouleau multicouche - poignées de poussée intégrées à l'étagère supérieur - profilés de retenue aux étagères inférieurs - roues multidirectionnelles ø 95 mm.

DE Servicewagen aus Holz. Massivholzstruktur - Ablageflächen aus Birkensperrholz - Schubgriffe eingebaut an der obersten Fläche - Mehrwegräder ø 95 mm.

i	CLP 2002 noce-walnut	CLP 2002 CA carbon	CLP 2002 B laccato bianco laquered white	CLP 2002 N laccato nero laquered black
cm	110 x 55 x 82(h) cm			
N.	2			
MAX Kg	80 Kg			
	750 €		920 €	

CLP 2002L40



CLP 2002L40 CA

IT Carrelli di servizio in legno. Struttura in legno massello - ripiani in multistrato di betulla - maniglie di spinta integrate nel piano superiore - ruote multidirezionali ø 95 mm.

EN Wooden service trolleys. Solid wood structure - birch multi-layered wood shelves - integrated push handles in the upper shelf - multidirectional wheels ø 95 mm.

FR Chariots de service en bois. Structure en bois massif - étagères en bouleau multicouche - poignées de poussée intégrées à l'étagère supérieur - roues multidirectionnelles ø 95 mm.

DE Servicewagen aus Holz. Massivholzstruktur - Ablageflächen aus Birkensperrholz - Schubgriffe eingebaut an der obersten Fläche - Mehrwegräder ø 95 mm.

i	CLP 2002L40 noce-walnut	CLP 2002L40 CA carbon
cm	110 x 40 x 82(h) cm	
N.	2	
MAX Kg	80 Kg	
	635 €	

Carrelli di servizio in legno
Wooden service trolleys

OPTIONAL



CLP 2003



CLP 2003 B

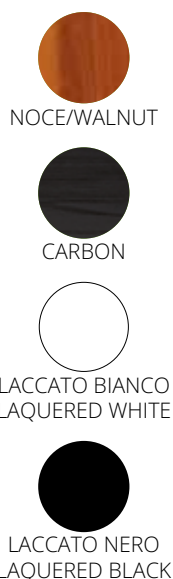

CLP 2003L40



CLP 2003L40 CA

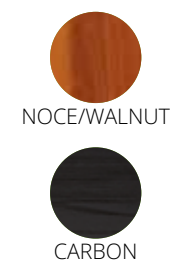

IT Carrelli di servizio in legno. Struttura in legno massello - ripiani in multistrato di betulla - maniglie di spinta integrate nel piano superiore - ringhiere di contenimento sui piani inferiori - ruote multidirezionali ø 95 mm.

EN Wooden service trolleys. Solid wood structure - birch multi-layered wood shelves - integrated push handles in the upper shelf - retaining rails on the lower shelves - multidirectional wheels ø 95 mm.

FR Chariots de service en bois. Structure en bois massif - étagères en bouleau multicouche - poignées de poussée intégrées à l'étagère supérieur - profilés de retenue aux étagères inférieurs - roues multidirectionnelles ø 95 mm.

DE Servicewagen aus Holz. Massivholzstruktur - Ablageflächen aus Birkensperrholz - Schubgriffe eingebaut an der obersten Fläche - Halterungen in den untersten Etagen - Mehrwegräder ø 95 mm.

IT Carrelli di servizio in legno. Struttura in legno massello - ripiani in multistrato di betulla - maniglie di spinta integrate nel piano superiore - ruote multidirezionali ø 95 mm.

EN Wooden service trolleys. Solid wood structure - birch multi-layered wood shelves - integrated push handles in the upper shelf - multidirectional wheels ø 95 mm.

FR Chariots de service en bois. Structure en bois massif - étagères en bouleau multicouche - poignées de poussée intégrées à l'étagère supérieur - roues multidirectionnelles ø 95 mm.

DE Servicewagen aus Holz. Massivholzstruktur - Ablageflächen aus Birkensperrholz - Schubgriffe eingebaut an der obersten Fläche - Mehrwegräder ø 95 mm.

i	CLP 2003 noce-walnut	CLP 2003 CA carbon	CLP 2003 B laccato bianco laquered white	CLP 2003 N laccato nero laquered black
cm	110 x 55 x 89(h) cm			
N.	3			
MAX Kg	80 Kg			
	990 €		1.245 €	

i	CLP 2003L40 noce-walnut	CLP 2003L40 CA carbon
cm	110 x 40 x 89(h) cm	
N.	3	
MAX Kg	80 Kg	
	810 €	

CL 2001



CL 2001 CA



CL 2000



CL 2000

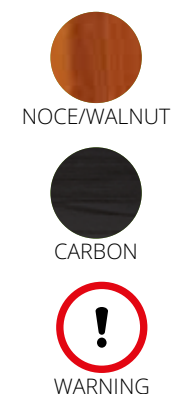

CL 2000 CA

IT Carrelli di servizio in legno. Struttura in legno multistrato di betulla - ripiani in nobilitato - cornice perimetrale e maniglia in legno massello - ruote multidirezionali di serie cromate ø 100 mm.

EN Wooden service trolleys. Birch multi-layered wood structure - melamine shelves - solid wood perimeter frame and handle - standard multidirectional chrome-plated wheels ø 100 mm.

FR Chariots de service en bois. Structure en bouleau multicouche - étagères en bois mélaminé - cadre périmétral et poignée en bois massif - de série roues multidirectionnelles chromées ø 100 mm.

DE Servicewagen aus Holz. Struktur aus Birkensperrholz - Regale aus melaminharzbeschichtetem Birkenholz - Zierrahmen und Griff aus Struktur aus Birkenfurnierholz - Ablagefläche aus Furnierholz - umlaufender Rahmen und Griff aus Massivholz - serienmäßig mit Mehrweg-Chromräder ø 100 mm.

	CL 2001 noce-walnut	CL 2001 CA carbon
	106 x 55 x 85(h) cm	
	2	
	80 Kg	
	840 €	

	CL 2000 noce-walnut	CL 2000 CA carbon
	86 x 55 x 85(h) cm	
	2	
	80 Kg	
	780 €	



Foto con OPTIONAL - n. 4 ruote con cuffia ottonata o cromata + A100 pianetto regipiatto (CL2001)
Photos with OPTIONAL - 4 Brass or chrome ball casters + A100 shelf (CL2001)
Photo avec ACCESSOIRES - 4 Roulette à bille en laiton ou chromée + A100 Étagère à plateaux (CL2001)
Abgebildet mit ZUBEHÖR - 4 Messing- oder Chrom-Kugelrolle + A100 Verdeckte Tablettablage (CL2001)

OPTIONAL



CL 2150



CL 2150



NOCE/WALNUT

CARBON

WARNING

CL 2151



CL 2151 CA



NOCE/WALNUT

CARBON

IT Carrelli di servizio in legno. Struttura in legno multistrato di betulla - ripiani in nobilitato - cornice perimetrale e maniglia in legno massello - ruote multidirezionali di serie cromate ø 100 mm.

EN Wooden service trolleys. Birch multi-layered wood structure - melamine shelves - solid wood perimeter frame and handle - standard multidirectional chrome-plated wheels ø 100 mm.

FR Chariots de service en bois. Structure en bouleau multicouche - étagères en bois mélaminé - cadre périmétral et poignée en bois massif - de série roues multidirectionnelles chromées ø 100 mm.

DE Servicewagen aus Holz. Struktur aus Birkensperrholz - Regale aus melaminharzbeschichtetem Birkenholz - Zierrahmen und Griff aus Struktur aus Birkenfurnierholz - Ablagefläche aus Furnierholz - umlaufender Rahmen und Griff aus Massivholz - serienmäßig mit Mehrweg-Chromräder ø 100 mm.

	CL 2150 noce-walnut	CL 2150 CA carbon
		
	86 x 55 x 85(h) cm	
	3	
	80 Kg	
	925 €	

	CL 2151 noce-walnut	CL 2151 CA carbon
		
	106 x 55 x 85(h) cm	
	3	
	80 Kg	
	985 €	

 Carrelli di servizio in legno
Wooden service trolleys



Foto con OPTIONAL - n. 4 ruote con cuffia ottonata o cromata
Photos with OPTIONAL - 4 Brass or chrome ball casters
Photo avec ACCESSOIRES - 4 Roulette à bille en laiton ou chromée
Abgebildet mit ZUBEHÖR - 4 Messing- oder Chrom-Kugelrolle

OPTIONAL

Espositore ghiacciaia. Struttura in legno con vasca e griglia in acciaio inox - cupola plexiglass - provvisto di 8 contenitori eutectici.

Icebox display. Wooden structure with stainless steel bowl and grill - Plexiglas dome - equipped with 8 eutectic containers.

Présentoir glacière. Structure en bois avec cuve et grille en acier inox - clochette en plexiglas - équipé de 8 conteneurs eutectiques.

Gefrierfachavitrine. Holzstruktur mit Edelstahlwanne und Gitter - Plexiglashaube - ausgestattet mit 8 eutektischen Behältern.

	A 1290 noce-walnut	A 1290 CA carbon
Mod.	CL 2001 CL 2151	CL 2001 CA CL 2151 CA
 cm	90 x 48,5 x 23(h) cm	
	930 €	



NOCE/WALNUT



CARBON

Vetrinetta con struttura in legno e cupola in plexiglass

Display with wooden structure and Plexiglas dome.

Présentoir avec structure en bois et clochette en plexiglas.

Vitrine mit Holzstruktur und Plexiglashaube.



NOCE/WALNUT



CARBON

	A 1299 noce-walnut	A 1299CA carbon	A 1298 noce-walnut	A 1298CA carbon
Mod.	CL 2000 CL 2150	CL 2000 CA CL 2150 CA	CL 2001 CL 2151	CL 2001 CA CL 2151 CA
 cm	70 x 50 x 22(h) cm		90 x 50 x 22(h) cm	
	400 €		430 €	

Carrelli di servizio in legno

WOODEN SERVICE TROLLEYS
CHARIOTS DE SERVICE EN BOIS
SERVICEWAGEN AUS HOLZ

A 100 CLP-CL-CLC	A 200 CLP-CL-CLC
Pianetto reggiplatto a scomparsa Retractable shelf Étagère à plateaux encastrée Verdeckte Tablettablage	Cassetto portaposate a 3 scomparti Cutlery drawer with 3 compartments Tiroir à couverts avec 3 compartiments Besteckschublade mit 3 Fächern
85 €	125 €

n. 4 ruote con cuffia ottonata o cromata
4 brass or chrome plated copper castors
4roulette à bille en laiton ou chromée - 4 Messing- oder Chrom-Kugelrolle



A800

A850

160 €

CLC 2012



CLC 2012

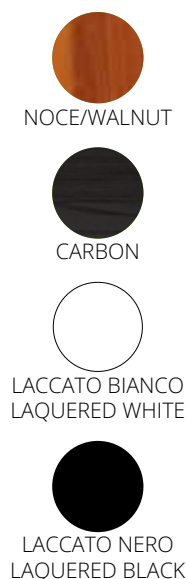

CLC 2013



CLC 2013 CA



IT Carrelli di servizio in legno con cupola. Struttura in legno massello - ripiani in multistrato di betulla - cupola semicircolare in plexiglass apribile su due lati - maniglie di spinta integrate nel piano superiore - ringhiere di contenimento sui piani inferiori - ruote multidirezionali \varnothing 95 mm.

EN Wooden service trolleys with dome. Solid wood structure - birch multi-layered wood shelves - half-circle dome in Plexiglas that opens on two sides - integrated push handles in the upper shelf - retaining rails on the lower shelves - multidirectional wheels \varnothing 95 mm.

FR Chariots de service en bois avec clochette. Structure en bois massif - étagères en bouleau multicouche - clochette en plexiglas de forme semi-circulaire avec ouverture sur les deux côtés - poignées de poussée intégrées à l'étagère supérieure - profilés de retenue aux étagères inférieurs - roues multidirectionnelles \varnothing 95 mm.

DE Servicewagen aus Holz für Kuchen. Massivholzstruktur - Ablageflächen aus Birkensperrholz - zweiseitig aufklappbare, halbrunde Plexiglashaube - Schubgriffe eingebaut an der obersten Fläche - Halterungen in den untersten Etagen - Mehrwegräder \varnothing 95 mm.

	CLC 2012 noce-walnut	CLC 2012 CA carbon	CLC 2012 B laccato bianco laquered white	CLC 2012 N laccato nero laquered black
	110 x 55 x 107(h) cm			
	2			
	80 Kg			
	1.080 €		1.250 €	

	CLC 2013 noce-walnut	CLC 2013 CA carbon	CLC 2013 B laccato bianco laquered white	CLC 2013 N laccato nero laquered black
	110 x 55 x 114(h) cm			
	3			
	80 Kg			
	1.320 €		1.575 €	

Carrelli di servizio in legno con cupola
Wooden service trolleys with dome

OPTIONAL

CL 2255 - CL 2260



CL 2255 CA



CL 2785



CL 2785

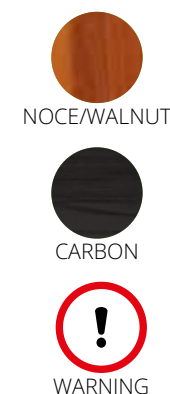

IT Carrelli di servizio in legno con cupola. Struttura portante in legno multistrato di betulla - cupola semicircolare in plexiglass apribile su due lati - maniglia di spinta in legno - 2 ripiani - ruote multidirezionali \varnothing 100 mm.

EN Wooden service trolleys with dome. Load-bearing structure in birch multi-layered wood - half-circle dome in Plexiglas that opens on two sides - wooden push handle - 2 shelves - multidirectional wheels \varnothing 100 mm.

FR Chariots de service en bois avec clochette. Structure portante en bouleau multicouche - clochette en plexiglas de forme semi-circulaire avec ouverture sur les deux côtés - poignée en bois - 2 étagères - roues multidirectionnelles \varnothing 100 mm.

DE Servicewagen aus Holz für Kuchen. Struktur aus Birkensperholz Birkenholz - zweiseitig aufklappbare, halbrunde Plexiglashaube - Schubgriff aus Holz - 2 Einlegeböden - Mehrwegräder \varnothing 100 mm.

IT Carrello di servizio in legno con cupola. Struttura portante in legno multistrato di betulla - cupola in plexiglass trasparente 150(h) mm - vasca e griglia in acciaio inox - 8 piastre eutettiche refrigeranti - ruote multidirezionali \varnothing 100 mm. Può contenere numero 5 bacinelle GN1/4 con 40(h) mm oppure 5 bacinelle GN1/6 con 40(h) mm.

EN Wooden service trolley with dome. Multi-layered birch wood supporting structure - clear Plexiglas dome 150(h) mm - stainless steel bowl and grid - 8 refrigerant eutectic plates - multidirectional wheels \varnothing 100 mm. It can contain 5 GN1/4 containers 40(h) mm or 5 GN1/6 containers 40(h) mm.

FR Chariot de service en bois avec clochette. Structure portante en bouleau multicouche - clochette en plexiglas transparent 150(h) mm - cuve et grille en acier inox - 8 plaques de refroidissement eutectiques - roues multidirectionnelles \varnothing 100 mm. Contient 5 bacs GN1/4 avec 40(h) mm ou 5 bacs GN1/6 avec 40(h) mm.

DE Servicewagen aus Holz für Kuchen. Tragkonstruktion aus Birkensperholz - transparente Plexiglashaube 150(h) mm - Edelstahlbehälter und Grill - 8 Eutektik-Kühlplatten - Mehrwegräder \varnothing 100 mm. Enthält 5 GN1/4 Behälter mit 40(h) mm oder 5 GN1/6 Behälter mit 40(h) mm.

	CL 2255 noce-walnut	CL 2255 CA carbon	CL 2260 noce-walnut	CL 2260 CA carbon
	86 x 55 x 110(h) cm		106 x 55 x 110(h) cm	
	2			
	80 Kg			
	1.040 €		1.120 €	

	CL 2785 noce-walnut	CL 2785 CA carbon
	106 x 55 x 108(h) cm	
	2	
	2.020 €	



Foto con OPTIONAL - n. 4 ruote con cuffia ottonata o cromata + A100 pianetto regipiatto + A200 cassetto portaposate
 Photos with OPTIONAL - 4 Brass or chrome ball casters + A100 shelf + A200 cutlery drawer
 Photo avec ACCESSOIRES - 4 Roulette à bille en laiton ou chromée + A100 Étagère à plateaux + A200 Tiroir à couverts
 Abgebildet mit ZUBEHÖR - 4 Messing- oder Chrom-Kugelrolle + A100 Verdeckte Tablettablage + A200 Besteckschublade

LP 800 - LP 850



LP 800 CE



NOCE/WALNUT



CARBON



CENERE
ASH GRAY

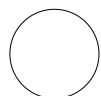

LACCATO BIANCO
LAQUERED WHITE

Cupole

CUP 800 - CUP 1000

IT Telaio e cupola in plexiglas trasparente acquistabile come optional e facilmente applicabile.

EN Clear Plexiglas frame and dome can be purchased as an option and easily installed.

FR Cadre et clochette en plexiglas transparent peuvent être achetés en option et facilement installés.

DE Rahmen und Haube aus durchsichtigem Plexiglas können als Option erworben und leicht angebracht werden.



IT Carrelli di servizio in legno. Struttura in legno massello - ripiani in nobilitato di betulla - reggi piatto incluso - ruote multidirezionali cromate ø 100 mm. Possibilità di utilizzo cupola con telaio in plexiglas trasparente (CUP 800) acquistabile come optional.

FR Chariots de service en bois. Structure en bois massif - étagères en placage de bouleau - porte-assiettes inclus - roues multidirectionnelles chromées ø 100 mm. Cloche avec cadre en plexiglas transparent (CUP 800) disponible en option.

EN Wooden service trolleys. Solid wood frame - birch veneer shelves - plate holders included - chromed multidirectional wheels ø 100 mm. Dome with clear plexiglass frame (CUP 800) available as an optional.

DE Servicewagen aus Holz. Struktur aus Massivholz - Einlegeböden aus Birkenfurnier - inkl. Tellerhalter - verchromte Mehrwegrädern ø 100 mm. Haube mit durchsichtigem Plexiglasrahmen (CUP 800) als Option erhältlich.

	LP 800 noce-walnut	LP 800 CA carbon	LP 800 CE cenere/ash gray	LP 800 B laccato bianco laquered white	LP 850 noce-walnut	LP 850 CA carbon	LP 850 CE cenere/ash gray	LP 850 B laccato bianco laquered white	CUP 800 mod. LP800 - LP850
	81 x 55 x 82(h) cm								70 x 50 x 22(h) cm
	2				3				-
	80 Kg								-
	980 €		1.150 €		1.200 €		1.370 €		430 €



32

Carrelli di servizio in legno
Wooden service trolleys

LP 1000 - LP 1050



LP 1000 B



LP 1050 CA

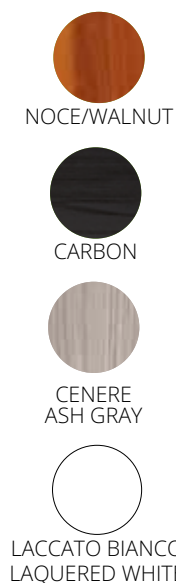



IT Carrelli di servizio in legno. Struttura in legno massello - ripiani in nobilitato di betulla - reggi piatto incluso - ruote multidirezionali cromate ø 100 mm. Possibilità di utilizzo cupola con telaio in plexiglax trasparente (CUP 1000) acquistabile come optional.

FR Chariots de service en bois. Structure en bois massif - étagères en placage de bouleau - porte-assiettes inclus - roues multidirectionnelles chromées ø 100 mm. Cloche avec cadre en plexiglas transparent (CUP 1000) disponible en option.

EN Wooden service trolleys. Solid wood frame - birch veneer shelves - plate holders included - chromed multidirectional wheels ø 100 mm. Dome with clear plexiglass frame (CUP 1000) available as an optional.

DE Servicewagen aus Holz. Struktur aus Massivholz - Einlegeböden aus Birkenfurnier - inkl. Tellerhalter - verchromte Mehrwegrädern ø 100 mm. Haube mit durchsichtigem Plexiglasrahmen (CUP 1000) als Option erhältlich.

	LP 1000 noce-walnut	LP 1000 CA carbon	LP 1000 CE cenere/ash gray	LP 1000 B laccato bianco laquered white	LP 1050 noce-walnut	LP 1050 CA carbon	LP 1050 CE cenere/ash gray	LP 1050 B laccato bianco laquered white	CUP 1000 mod. LP1000 - LP1050
	115 x 55 x 82(h) cm								90 x 50 x 22(h) cm
	2			3			-		
	80 Kg								-
	1.035 €		1.205 €		1.270 €		1.440 €		480 €

CL 2751 - CL 2752 CL 2750



NOCE/WALNUT



CARBON



CL 2751



CL 2752 CA

- IT** Carrelli Flambè. Struttura portante in legno multistrato di betulla - rivestimento in legno massello di castagno - piano di cottura in acciaio inox - ribaltina laterale - portabottiglie in acciaio cromato - 2 cassetti - vano porta bombola da 2 kg - 2 ruote con freno \varnothing 100 mm.
- EN** Flambé trolleys. Load-bearing structure in one-piece multi-layered wood - solid chestnut wood lining - stainless steel cooking plate - side folding panel - chrome-plated steel bottle rack - 2 drawers - 2 kg gas bottle compartment - 2 wheels with catch \varnothing 100 mm.
- FR** Chariots Flambé. Structure portante en bois de bouleau multicouche à structure monocoque - revêtement en châtaignier massif - plaque de cuisson en acier inox - porte-bouteille en acier chromé - 2 tiroirs - compartiment porte-bouteille de 2 kg - 2 roues avec frein \varnothing 100 mm.
- DE** Flambè-Wagen. Monoblock Struktur aus Birkensperrholz - Verkleidung aus massivem Kastanienholz - Kochplatte aus Edelstahl - Seitenklappe - Flaschenständer aus verchromtem Stahl- 2 Schubladen - 2 kg Gasflaschenfach - 2 räder mit Bremse \varnothing 100 mm.

	CL 2751 noce-walnut	CL 2751 CA carbon	CL 2752 noce-walnut	CL 2752 CA carbon
	107/145 x 58 x 91(h) cm			
	1 piastra - 1 fuoco 1 plate - 1 burner		2 piastre a 1 fuoco separato 2 plates 1 separate burner	
	35 Kg		35 Kg	
	1.830 €		2.160 €	
	CL 2750 noce-walnut		CL 2750 CA carbon	
	107/145 x 58 x 91(h) cm			
	1 piastra - 2 fuochi 1 plate - 2 burners			
	35 Kg			
	2.000 €			

CF 1200 - CF 1201 CF 1202



NOCE/WALNUT



CARBON



CF 1201



CF 1200



CF 1202 CA

IT Carrelli Flambè. Struttura portante in legno nobilitato - piano di cottura in acciaio inox con bruciatore regolabile - ribaltina laterale - maniglia di spinta in acciaio cromato - portabottiglie in acciaio cromato - 1 cassetto - 1 sportello vano porta bombola da 3 Kg - 2 ruote con freno \varnothing 100 mm.

EN Flambé trolleys. Load-bearing structure in laminated wood - stainless steel cooking plate with adjustable burner - side folding panel - chrome-plated steel push handle - chrome-plated steel bottle rack - 1 drawer - 3 kg gas bottle compartment - 2 wheels with catch \varnothing 100 mm.

FR Chariots Flambé. Structure portante en bois mélaminé - plaque de cuisson en acier inox avec brûleur réglable - volet latéral - poignée de poussée en acier chromé - porte-bouteille en acier chromé - 1 tiroir - compartiment avec porte pour bouteille de 3 kg - 2 roues avec frein \varnothing 100 mm.

DE Flambè-Wagen. Struktur aus melaminharzbeschichtetem Holz - Kochplatte aus Edelstahl mit einstellbarem Brenner - Schubgriff aus verchromtem Stahl - Flaschenständeraus verchromtem Stahl - 1 Schublade - 3 Kg Gasflaschenfach - 2 räder mit Bremse \varnothing 100 mm.

Carrelli Flambé Flambè Trolleys

AB2 CL2750-51-52	AB3 CF1200-1201-1202
Bombola gas 2 kg (vuota) Gas bottle 2 kg (empty) Bouteille de gaz 2 kg (vide) Gasflasche 2 kg (leer)	Bombola gas 3 kg (vuota) Gas bottle 3 kg (empty) Bouteille de gaz 3 kg (vide) Gasflasche 3 kg (leer)
	
90 €	95 €

	CF 1200 noce-walnut	CF 1200 CA carbon	CF 1201 noce-walnut	CF 1201 CA carbon
				
	105/137 x 57 x 91(h) cm			
	1 piastra - 1 fuoco 1 plate - 1 burner		1 piastra - 2 fuochi 1 plate - 2 burners	
	35 Kg			
	1.340 €		1.510 €	
	CF 1202 noce-walnut	CF 1202 CA carbon		
				
	105/137 x 57 x 91(h) cm			
	2 piastre a 1 fuoco separato 2 plates 1 separate burner			
	35 Kg			
	1.675 €			

Carrelli Flambè
Flambè trolleys



Foto con OPTIONAL - n. 4 ruote con cuffia ottonata o cromata
Photos with OPTIONAL - 4 Brass or chrome ball casters
Photo avec ACCESSOIRES - 4 Roulette à bille en laiton ou chromée
Abgebildet mit ZUBEHÖR - 4 Messing- oder Chrom-Kugelrolle

ML 3202SS



ML 3203SS CE



NOCE/WALNUT



CARBON



CENERE
ASH GRAY

A260

Applicazione tramoggia
Overprice hopper

180 €

IT Mobili di servizio in legno. Mobili di servizio bassi doppi - struttura e pannelli in nobilitato - 2 cassetti portaposate di cui 1 con separatore - 2 sportelli - ruote multidirezionali \varnothing 50 mm. Optional tramoggia A260.

EN Wooden service cabinets. Low double service cabinets - melamine structure and panels - 2 cutlery drawers, 1 with separator - 2 doors - multidirectional wheels \varnothing 50 mm. Optional hopper A260.

FR Meubles de service en bois. Meubles bas de service double - structure et panneaux en mélaminé - 2 tiroirs à couverts dont 1 avec séparateur - 2 portes - roues multidirectionnelles \varnothing 50 mm. Trémie A260 en option.

DE Servicemöbel aus Holz. Niedrige Doppelservicemöbel - Struktur und Blenden aus Melamin - 2 Besteckschubladen, davon 1 mit Trennwand - 2 Türen - Mehrwegräder \varnothing 50 mm. Auf Wunsch Trichter A260.

	ML 3202SS N noce-walnut	ML 3202SS CA carbon	ML 3202SS CE cenero-ash gray
			
	90 x 48 x 87(h) cm		
	2 sportelli - 2 cassetti 2 doors - 2 drawers		
	945 €		

ML 3150ST ML 3100SS



ML 3100SS



ML 3150ST CA

ML 3212SS

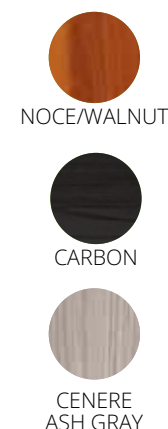

ML 3212SS CE

A260

Applicazione tramoggia
Overprice hopper

180 €

IT Mobili di servizio alti doppi - struttura e pannelli in nobilitato con bordi protetti da profilo in gomma - alzatina con 2 mensole - 2 cassetti portaposate di cui 1 con separatore - 2 sportelli (SS) oppure 1 sportello e 1 tramoggia (ST) - ruote multidirezionali ø 50 mm.

EN High double service cabinets - structure and panels in melamine with edges protected by rubber profile - backsplash with 2 shelves - 2 cutlery drawers, 1 with separator - 2 doors (SS) or 1 door and 1 hopper (ST) - multidirectional wheels ø 50 mm.

FR Meubles hauts de service double - structure et panneaux en mélaminé avec bords en caoutchouc - dossier avec 2 étagères - 2 tiroirs à couverts dont 1 avec séparateur - 2 portes (SS) ou 1 porte et 1 trémie (ST) - roues multidirectionnelles ø 50 mm.

DE Hohe Doppelservicemöbel - Struktur und Blenden aus Melamin mit Gummikantenschutz - Rückwand mit 2 Regalen - 2 Besteckschubladen, davon 1 mit Trennwand - 2 Türen (SS) oder 1 Tür und 1 Trichter (ST) - Mehrwegräder ø 50 mm.

IT Mobili di servizio alti doppi - struttura e pannelli in nobilitato - 2 cassetti portaposate di cui 1 con separatore - 2 sportelli - ruote multidirezionali ø 50 mm. Opzionale tramoggia A260.

EN High double service cabinets - melamine structure and panels - 2 cutlery drawers, 1 with separator - 2 doors - multidirectional wheels ø 50 mm. Optional hopper A260.

FR Meubles hautes de service double - structure et panneaux en mélaminé - 2 tiroirs à couverts dont 1 avec séparateur - 2 portes - roues multidirectionnelles ø 50 mm. Trémie A260 en option.

DE Hohe Doppelservicemöbel - Struktur und Blenden aus Melamin - 2 Besteckschubladen, davon 1 mit Trennwand - 2 Türen - Mehrwegräder ø 50 mm. Auf Wunsch Trichter A260.

	ML 3150ST noce-walnut	ML 3150ST CA carbon	ML 3100SS noce-walnut	ML 3100SS CA carbon
	95 x 49 x 144(h) cm			
	95 x 49 x 144(h) cm			
	1 sportello - 1 tramoggia - 2 cassetti 1 door - 1 hopper - 2 drawers		2 sportelli - 2 cassetti 2 doors - 2 drawers	
	1.285 €		1.120 €	

	ML 3212SS N noce-walnut	ML 3212SS CA carbon	ML 3212SS CE cenere-ash gray
	90 x 48 x 155(h) cm		
	90 x 48 x 155(h) cm		
	2 sportelli - 2 cassetti 2 doors - 2 drawers		
	1.145 €		

Mobili di servizio in legno
Wooden serving furniture

ML 5050

IT Mobile di servizio alto singolo - struttura e pannelli in nobilitato - 1 cassetto portaposate con separatore - 1 cassetto libero - 1 sportello. Possibilità di mensola montabile a sinistra o destra come optional.

EN High single service cabinet - structure and panels in melamine - 1 cutlery drawer with separator - 1 free drawer - 1 door. Optional left or right hand fitted shelf.

FR Meuble de service haut simple - structure et panneaux en mélamine - 1 tiroir à couverts avec séparateur - 1 tiroir libre - 1 porte. Étagère à monter à gauche ou à droite en option.

DE Einzelner hoher Servicemöbel - Struktur und Blenden aus Melamin - 1 Besteckschublade mit Trennwand - 1 freie Schublade - 1 Tür. Einlegeboden wahlweise links oder rechts einsetzbar.

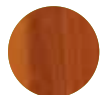

NOCE/WALNUT



CARBON



CENERE
ASH GRAY



ML 5050 CA

i	ML 5050 N noce-walnut	ML 5050 CA carbon	ML 5050 CE cenere-ash gray
↗ cm	45 x 49 x 144(h) cm		
	1 sportello - 2 cassetti 1 door - 2 drawers		
	910 €		





Mobili di servizio in legno
Wooden serving furniture



Mensola per mobile di servizio

SHELF FOR SERVICE CABINET
ÉTAGÈRE POUR ARMOIRE DE SERVICE
EINLEGEBODEN FÜR SERVICEMÖBEL

	A5050 N noce-walnut	A5050 CA carbon	A5050 CE cenere-ash gray
	500 x 250 mm		
	55 €		

ML 5050 CE
CON OPTIONAL MENSOLA
WITH OPTIONAL SHELF



ML 5050 CE

Mobili di servizio in legno
Wooden serving furniture

ML 3204SS



NOCE/WALNUT



CARBON



CENERE
ASH GRAY

A260

Applicazione tramoggia
Overprice hopper

180 €

ML 3204SS CE

IT Mobili di servizio bassi tripli - struttura e pannelli in nobilitato - 3 cassetti portaposate di cui 2 con separatore - 2 sportelli - 1 vano interno - ruote multidirezionali ø 50 mm. Optional tramoggia A260.

EN Low triple service cabinets - melamine structure and panels - 3 cutlery drawers, 2 with separator - 2 doors - 1 internal compartment - multidirectional wheels ø 50 mm. Optional hopper A260.

FR Meubles bas de service triple - structure et panneaux mélaminés - 3 tiroirs à couverts, dont 2 avec séparateur - 2 portes - 1 compartiment intérieur - roues multidirectionnelles ø 50 mm. Trémie A260 en option.

DE Niedrige Trippelservicemöbel - Struktur und Blenden aus Melamin - 3 Besteckschubladen, davon 2 mit Trennwand - 2 Türen - 1 Innenfach - Mehrwegräder ø 50 mm. Auf Wunsch Trichter A260.

ML 3214SS



NOCE/WALNUT



CARBON



CENERE
ASH GRAY

ML 3214SS CA

IT Mobili di servizio alti tripli - struttura e pannelli in nobilitato - 3 cassetti portaposate di cui 2 con separatore - 2 sportelli - 1 vano interno - ruote multidirezionali ø 50 mm.

EN High triple service cabinets - melamine structure and panels - 3 cutlery drawers, 3 with separator - 2 doors - 1 internal compartment - multidirectional wheels ø 50 mm.

FR Meubles de service hautes triple - structure et panneaux en mélaminé - 3 tiroirs à couverts dont 2 avec séparateur - 2 portes - 1 compartiment intérieur - roues multidirectionnelles ø 50 mm.

DE Hohe Trippelservicemöbel - Struktur und Blenden aus Melamin - 3 Besteckschubladen, davon 2 mit Trennwand - 2 Türen - 1 Innenfach - Mehrwegräder ø 50 mm.

	ML 3204SS N noce-walnut	ML 3204SS CA carbon	ML 3204SS CE cenere-ash gray
	136 x 48 x 87(h) cm		
	2 sportelli - 3 cassetti - 1 vano interno 2 doors - 3 drawers - 1 internal compartment		
	1.235 €		

	ML 3214SS N noce-walnut	ML 3214SS CA carbon	ML 3214SS CE cenere-ash gray
	136 x 48 x 155(h) cm		
	2 sportelli - 3 cassetti - 1 vano interno 2 doors - 3 drawers - 1 internal compartment		
	1.500 €		



40

Mobili di servizio in legno
Wooden serving furniture

ML 3212SSP

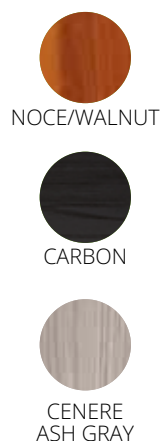

A270

Applicazione tramoggia
Overprice hopper

180 €

ML 3212SSP CA

ML 3214SSP

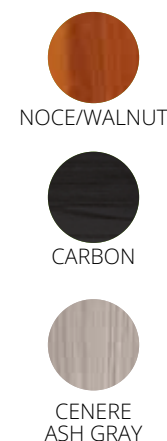

A270

Applicazione tramoggia
Overprice hopper

180 €

ML 3214SSP N

IT Mobili di servizio alti doppi - struttura e pannelli in nobilitato - struttura reggi pensili in acciaio plastificato - 2 pensili - 2 cassetti portaposate di cui 1 con separatore - 2 sportelli - ruote multidirezionali \varnothing 50 mm. Optional tramoggia A270-A270W.

EN High double service cabinets - melamine structure and panels - plastic-coated steel wall cabinets support structure - 2 wall cabinets - 2 cutlery drawers, 1 with separator - 2 doors - multidirectional wheels \varnothing 50 mm. Optional hopper A270-A270W.

FR Meubles hautes de service double - structure et panneaux en mélaminé - 2 tiroirs à couverts dont 1 avec séparateur - 2 portes - roues multidirectionnelles \varnothing 50 mm. Trémie A270-A270W en option.

DE Hohe Servicemöbel - Struktur und Blenden aus Melamin - kunststoffbeschichtete Stahl-Halterungen - 2 Hängeschränke - 2 Besteckschubladen, davon 1 mit Trennwand - 2 Türen - Mehrwegräder \varnothing 50 mm. Auf Wunsch Trichter A270-A270W.

IT Mobili di servizio alti tripli - struttura e pannelli in nobilitato - struttura reggi pensili in acciaio plastificato - 3 pensili - 3 cassetti portaposate di cui 2 con separatore - 2 sportelli - 1 vano interno - ruote multidirezionali \varnothing 50 mm. Optional tramoggia A270.

EN High triple service cabinets - melamine structure and panels - plastic-coated steel wall cabinets support structure - 3 wall cabinets - 3 cutlery drawers, 2 with separator - 2 doors - 1 internal compartment - multidirectional wheels \varnothing 50 mm. Optional hopper A270.

FR Meubles de service hautes triple - structure et panneaux en mélaminé - structure de supports pour meubles à mur en acier plastifié - 3 tiroirs à couverts dont 2 avec séparateur - 2 portes - 1 compartiment intérieur - roues multidirectionnelles \varnothing 50 mm. Trémie A270 en option.

DE Hohe Trippelservicemöbel - Struktur und Blenden aus Melamin - kunststoffbeschichtete Stahl-Halterungen - 3 Hängeschränke - 3 Besteckschubladen, davon 2 mit Trennwand - 2 Türen - 1 Innenfach - Mehrwegräder \varnothing 50 mm. Auf Wunsch Trichter A270.

	ML 3212SSP N noce-walnut	ML 3212SSP CA carbon	ML 3212SSP CE cenere-ash gray
	92 x 48 x 153(h) cm		
	2 pensili - 2 sportelli - 2 cassetti 2 wall cabinets - 2 doors - 2 drawers		
	1.480 €		

	ML 3214SSP N noce-walnut	ML 3214SSP CA carbon	ML 3214SSP CE cenere-ash gray
	137 x 48 x 153(h) cm		
	3 pensili - 2 sportelli - 3 cassetti - 1 vano interno 3 wall cabinets - 2 doors - 3 drawers - 1 internal compartment		
	1.865 €		

Mobili di servizio in legno
Wooden serving furniture



Carrelli di servizio in acciaio inox

STAINLESS STEEL SERVICE TROLLEYS
CHARIOTS DE SERVICE EN ACIER INOX
SERVICEWAGEN AUS EDELSTAHL

CA 1380
CA 1381

CA 1382
CA 1383

CA 1384
CA 1385

A 512

Ruote con freno - Wheels with catch
Roues avec frein - Räder mit Bremse

10 € cad./each



IT Struttura tubolare 20x20 mm in acciaio inox **AISI 304** - ripiani in acciaio inox **AISI 304** piegati, satinati, insonorizzati - paracolpi in gomma - ruote multidirezionali \varnothing 125 mm.

FR Structure tubulaire 20x20 mm en acier inox **AISI 304** - étagères en acier inox **AISI 304** pliées, satinées, insonorisées - butoirs en caoutchouc - roues multidirectionnelles \varnothing 125 mm.

EN Tubular structure 20x20 mm in stainless steel **AISI 304** - **AISI 304** stainless steel folded, satin-finished, soundproofed shelves - rubber shock absorber - multidirectional wheels \varnothing 125 mm.

DE Rohrrahmen 20x20 mm aus Edelstahl **AISI 304** - Gebogene, Schallgedämmte Ablageflächen aus Edelstahl **AISI 304** mit satiniertes Oberfläche - Gummistoßschutz - Mehrwegräder \varnothing 125 mm.

	CA 1380	CA 1381	CA 1382	CA 1383	CA 1384	CA 1385
	91 x 57 x 172(h) cm	111 x 57 x 172(h) cm	91 x 57 x 96(h) cm	111 x 57 x 96(h) cm	91 x 57 x 96(h) cm	111 x 57 x 96(h) cm
	4		2		3	
	80 x 50 cm	100 x 50 cm	80 x 50 cm	100 x 50 cm	80 x 50 cm	100 x 50 cm
	80 Kg		80 Kg		80 Kg	
	630 €	725 €	370 €	415 €	490 €	560 €

Carrelli di servizio in acciaio inox
Stainless steel service trolleys

CA 1390
CA 1391

CA 1410
CA 1411

CA 1412 - CA 1413
CA 1414

A 512

Ruote con freno - Wheels with catch
Roues avec frein - Räder mit Bremse

10 € cad./each



IT Struttura tubolare \varnothing 25 mm in acciaio inox **AISI 304** - ripiani in acciaio inox **AISI 304**, stampati in forma di vassoio con bordi arrotondati e alto spessore, insonorizzati e con finitura satinata - paracolpi in gomma - ruote multidirezionali \varnothing 125 mm.

FR Structure tubulaire \varnothing 25 mm en acier inox **AISI 304** - étagères en acier inox **AISI 304**, moulées en forme de plateau à bords arrondis et de grande épaisseur, insonorisées et satinées - butoirs en caoutchouc - roues multidirectionnelles \varnothing 125 mm.

EN Tubular structure \varnothing 25 mm in stainless steel **AISI 304** - **AISI 304** stainless steel shelves, tray-shaped with rounded edges and high thickness, soundproofed and with satin finish - rubber shock absorber - multidirectional wheels \varnothing 125 mm.

DE Rohrrahmen \varnothing 25 mm aus Edelstahl **AISI 304** - Schallgedämmte Ablageflächen aus Edelstahl **AISI 304**, Tablett förmig bedruckt mit abgerundeten Kanten und satinierter Oberfläche - Gummistoßschutz-Mehrwegräder \varnothing 125 mm.

	CA 1390	CA 1391	CA 1410	CA 1411	CA 1412	CA 1413	CA 1414
	90 x 60 x 94(h) cm	110 x 60 x 94(h) cm	90 x 60 x 104(h) cm	110 x 60 x 104(h) cm	100 x 70 x 94(h) cm	110 x 70 x 94(h) cm	128 x 70 x 94(h) cm
	2		3		2		
	80 x 50 cm	100 x 50 cm	80 x 50 cm	100 x 50 cm	90 x 60 cm	100 x 60 cm	120 x 60 cm
	100 Kg		100 Kg		100 Kg		
	350 €	395 €	460 €	515 €	415 €	450 €	550 €

CA 1415 - CA 1416
CA 1417

CA 1424
CA 1425

CA 1426
CA 1427

A 512

Ruote con freno - Wheels with catch
Roues avec frein - Räder mit Bremse

10 € cad./each



CA 1415



CA 1424



CA 1426

IT Struttura tubolare \varnothing 25 mm in acciaio inox **AISI 304** - ripiani in acciaio inox **AISI 304**, stampati in forma di vassoio con bordi arrotondati e alto spessore, insonorizzati e con finitura satinata - paracolpi in gomma - ruote multidirezionali \varnothing 125 mm.

FR Structure tubulaire \varnothing 25 mm en acier inox **AISI 304** - étagères en acier inox **AISI 304**, moulées en forme de plateau à bords arrondis et de grande épaisseur, insonorisées et satinées - butoirs en caoutchouc - roues multidirectionnelles \varnothing 125 mm.

EN Tubular structure \varnothing 25 mm in stainless steel **AISI 304** - **AISI 304** stainless steel shelves, tray-shaped with rounded edges and high thickness, soundproofed and with satin finish - rubber shock absorber - multidirectional wheels \varnothing 125 mm.

DE Rohrrahmen \varnothing 25 mm aus Edelstahl **AISI 304** - Schallgedämmte Ablageflächen aus Edelstahl **AISI 304**, Tablett förmig bedruckt mit abgerundeten Kanten und satiniertes Oberfläche - Gummistoßschutz-Mehrwegräder \varnothing 125 mm.

	CA 1415	CA 1416	CA 1417	CA 1424	CA 1425	CA 1426	CA 1427
							
 cm	100 x 70 x 104(h) cm	110 x 70 x 104(h) cm	128 x 70 x 104(h) cm	90 x 60 x 140(h) cm	110 x 60 x 140(h) cm	90 x 60 x 170(h) cm	110 x 60 x 170(h) cm
 N.	3			4		5	
 mm	90 x 60 cm	100 x 60 cm	120 x 60 cm	80 x 50 cm	100 x 50 cm	80 x 50 cm	100 x 50 cm
 MAX Kg	100 Kg			100 Kg		100 Kg	
	550 €	635 €	815 €	600 €	670 €	750 €	840 €

Carrelli di servizio in acciaio inox
Stainless steel service trolleys

CA 1390S - CA 1391S



CA 1390S

* Sacchi non inclusi.
Bags not included.
Sacs non fournis.
Säcke nicht enthalten.

h 52 cm

IT Carrelli portarifiuti. Carrelli di servizio in acciaio inox. Struttura tubolare \varnothing 25 mm in acciaio inox **AISI 304** - ripiani in acciaio inox **AISI 304** con fori per sacchi portarifiuti - paracolpi in gomma - ruote multidirezionali \varnothing 125 mm.

EN Garbage trolley. Stainless steel service trolleys. Tubular structure \varnothing 25 mm in stainless steel **AISI 304** - stainless steel **AISI 304** shelves with holes for garbage bags - rubber stop - multidirectional wheels \varnothing 125 mm.

FR Récipient à déchets. Chariots de service en acier inox Structure tubulaire \varnothing 25 mm en acier inox **AISI 304** - étagères en acier inox **AISI 304** avec trous pour sacs à déchets - butoir en caoutchouc - roues multidirectionnelles \varnothing 125 mm.

DE Abfallwagen. Servicewagen aus Edelstahl. Rohrrahmen \varnothing 25 mm aus Edelstahl **AISI 304** - Ablageflächen aus Edelstahl **AISI 304** mit Löchern für Abfallsäcke - Gummistoßschutz- Mehrwegräder \varnothing 125 mm.





	CA 1390S	CA 1391S
 cm	90 x 60 x 94(h) cm	110 x 60 x 94(h) cm
 N.	2	
 mm	80 x 50 cm	100 x 50 cm
 MAX Kg	100 Kg	
	430 €	475 €

CA 1391S2



* Sacchi non inclusi.
Bags not included.
Sacs non fournis.
Säcke nicht enthalten.

h 52 cm

	CA 1391S2
 cm	110 x 60 x 94(h) cm
 N.	2
 mm	100 x 50 cm
 MAX Kg	100 Kg
	545 €

A 512

Ruote con freno - Wheels with catch
Roues avec frein - Räder mit Bremse

10 € cad./each

CA 1390C - CA 1391C



h 52 cm

A 512

Ruote con freno - Wheels with catch
Roues avec frein - Räder mit Bremse

10 € cad./each

CA 1390C

IT Carrello di servizio con cupola. Struttura tubolare \varnothing 25 mm in acciaio inox **AISI 304** - ripiani in acciaio inox **AISI 304**, stampati, satinati e insonorizzati - cupola in plexiglass semicircolare apribile su due lati - paracolpi in gomma - ruote multidirezionali \varnothing 125 mm.

EN Service trolley with dome. Tubular structure \varnothing 25 mm in stainless steel **AISI 304** - stainless steel **AISI 304** folded, satin-finished, soundproofed shelves - half-circle dome in Plexiglas that opens on two sides - rubber shock absorber - multidirectional wheels \varnothing 125 mm.

FR Chariot de service avec clochette. Structure tubulaire \varnothing 25 mm en acier inox **AISI 304** - étagères en acier inox **AISI 304** moulées, satinées, insonorisées - clochette en plexiglas semi-circulaire s'ouvrant sur deux côtés - butoir en caoutchouc - roues multidirectionnelles \varnothing 125 mm.

DE Servicewagen für Kuchen. Rohrrahmen \varnothing 25 mm aus Edelstahl **AISI 304** - vorgeformte schallgedämmte Ablageflächen aus Edelstahl **AISI 304** mit satinierter Oberfläche - zweiseitig aufklappbare, halbrunde Plexiglashaube - Gummistoßschutz- Mehrwegräder \varnothing 125 mm.

i	CA 1390C	CA 1391C
cm	90 x 60 x 109(h) cm	110 x 60 x 109(h) cm
N.	2	
MAX Kg	100 Kg	
	640 €	690 €

CA 1165



h 50 cm

IT Carrello di servizio in acciaio inox con piastre eutettiche refrigeranti. Struttura tubolare in acciaio inox **AISI 304** 20x20 mm - 8 piastre eutettiche refrigerate incluse - coperchio in plexiglass 150(h) mm - vasca e griglia in acciaio inox - capacità di n. 5 bacinelle GN1/4 e n. 5 bacinelle GN1/6 65(h) mm. Bacinelle non incluse nel prezzo.

EN Stainless steel service trolley with refrigerated electric plates. Tubular structure 20x20 mm in stainless steel **AISI 304** - 8 refrigerated eutectic plates included - Plexiglas lid 150(h) mm - stainless steel bowl and grid - equipped for up to 5 GN1/4 containers and 5 GN1/6 65(h) mm containers. Containers not included in the price.

FR Chariot de service en acier inox avec plaques de refroidissement électriques. Structure tubulaire en acier inox **AISI 304** 20x20 mm - 8 plaques eutectiques réfrigérées incluses - couvercle en plexiglas 150(h) mm - cuve et grille en acier inox - équipés pour une capacité de 5 bacs GN1/4 et 5 bacs GN1/6 65(h) mm. Bacs non compris dans le prix.

DE Edelstahl-Servicewagen mit elektrischen Kühlplatten. Rohrrahmen aus Edelstahl **AISI 304** 20x20 mm - 8 eutektische Kühlplatten im Lieferumfang enthalten - Plexiglasdeckel 150(h) mm - Edelstahlwanne und Gitter - enthält 5 GN1/4 Behälter mit 65(h) mm oder 5 GN1/6 Behälter mit 65(h) mm. Behälter nicht im Preis inbegriffen.

i	CA 1165
cm	108 x 57 x 104(h) cm
N.	2
MAX Kg	80 Kg
	1.075 €

Carrelli di servizio in acciaio inox con cupola
Stainless steel service trolleys with dome

CA 1388



A 512

Ruote con freno - Wheels with catch
Roues avec frein - Räder mit Bremse

10 € cad./each

CA 1389



IT Carrello di servizio in acciaio inox per sbarazzo. Struttura tubolare in acciaio inox **AISI 304**, 20x20 mm - vasca in acciaio inox **AISI 304** - piano inferiore in acciaio inox piegato - ruote multidirezionali ø 125 mm.

EN Stainless steel service trolley for disposal. Tubular structure in stainless steel **AISI 304**, 20x20 mm - stainless steel **AISI 304** bowl - lower folded stainless steel shelf- multidirectional wheels ø 125 mm.

FR Chariot de service en acier inox pour le rangement. Structure tubulaire en acier inox **AISI 304**, 20x20 mm - cuve en acier inox **AISI 304** - plateau inférieur courbé en acier inox - roues multidirectionnelles ø 125 mm.







DE Servicewagen aus Edelstahl zum Abräumen. Rohrrahmen aus Edelstahl **AISI 304**, 20x20 mm - Wanne aus Edelstahl **AISI 304** - Bodenfläche aus gebogenem Edelstahl - Mehrwegräder ø 125 mm.







IT Carrello di servizio in acciaio inox per sbarazzo. Struttura tubolare in acciaio inox **AISI 304**, 20x20 mm - vasche in acciaio inox **AISI 304** insonorizzate 150(h) mm - ruote multidirezionali ø 125 mm.

EN Stainless steel service trolley for disposal. Tubular structure in stainless steel **AISI 304**, 20x20 mm - stainless steel **AISI 304** soundproofed bowls 150(h) mm - multidirectional wheels ø 125 mm.

FR Chariot de service en acier inox pour le rangement. Structure tubulaire en acier inox **AISI 304**, 20x20 mm - cuve en acier inox **AISI 304** insonorisées 150(h) mm - plateau inférieur courbé en acier inox - roues multidirectionnelles ø 125 mm.

DE Servicewagen aus Edelstahl zum Abräumen. Rohrrahmen aus Edelstahl **AISI 304**, 20x20 mm - schallgedämmte Wanne aus Edelstahl **AISI 304** 150(h) mm - Mehrwegräder ø 125 mm.

	CA 1388
	101 x 57 x 97(h) cm
	2
	90 x 50 cm
	1 x 150(h) mm
	80 Kg
	445 €

	CA 1389
	101 x 57 x 97(h) cm
	2
	90 x 50 cm
	2 x 150(h) mm
	80 Kg
	495 €

CA 1396



h 35 cm

A 512

Ruote con freno - Wheels with catch
Roues avec frein - Räder mit Bremse

10 € cad./each

CA 1386 - CA 1387



h 50 cm

CA 1386

IT Carrello di servizio in acciaio inox per sbarazzo. Struttura tubolare in acciaio inox **AISI 304**, 20x20 mm - vasche insonorizzate in acciaio inox **AISI 304**, 65(h) mm - ruote multidirezionali \varnothing 125 mm.

EN Stainless steel service trolley for disposal. Tubular structure in stainless steel **AISI 304**, 20x20 mm - stainless steel **AISI 304** soundproofed bowls, 65(h) mm - multidirectional wheels \varnothing 125 mm.

FR Chariot de service en acier inox pour le rangement. Structure tubulaire en acier inox **AISI 304**, 20x20 mm - cuve en acier inox **AISI 304** insonorisées 65(h) mm - roues multidirectionnelles \varnothing 125 mm.

DE Servicewagen aus Edelstahl zum Abräumen. Rohrrahmen aus Edelstahl **AISI 304**, 20x20 mm - schallgedämmte Wanne aus Edelstahl **AISI 304** 65(h) mm - Mehrwegräder \varnothing 125 mm.

IT Carrello portabacinelle con struttura tubolare tonda \varnothing 25 mm in acciaio inox **AISI 304** - livello superiore adatto a contenere fino a 3 bacinelle GN1/1 o 2 bacinelle GN1/1 - piano inferiore in acciaio inox **AISI 304**, piegato e insonorizzato - paracolpi in gomma - ruote multidirezionali \varnothing 125 mm. Bacinelle escluse.

EN Containers trolley with round tubular frame \varnothing 25 mm in stainless steel **AISI 304** - upper level designed to accommodate up to 3 GN1/1 or 2 GN1/1 containers - lower level in stainless steel **AISI 304**, folded and soundproofed - rubber shock absorber - multidirectional wheels \varnothing 125 mm. Containers not included.

FR Chariot porte-bacs avec structure tubulaire ronde \varnothing 25 mm en acier inox **AISI 304** - niveau supérieur pour 3 bacs GN1/1 ou 2 bacs GN1/1 - niveau inférieur en acier inox **AISI 304**, plié et insonorisé - butoir en caoutchouc - roues multidirectionnel \varnothing 125 mm. Bacs non compris

DE Behälterhalterwagen mit Rohrrahmen \varnothing 25 mm aus Edelstahl **AISI 304** - obere Ebene zur Aufnahme von bis zu 3 GN1/1 oder 2 GN1/1 Behälter - vorgeformte, schallgedämmte Bodenfläche aus Edelstahl - Gummistoßschutz - Mehrwegräder \varnothing 125 mm. Behälter nicht enthalten

i	CA 1396
↗ cm	91 x 57 x 97(h) cm
N.	2
mm	90 x 50 cm
	2 x 65(h) mm
MAX Kg	80 Kg
	440 €

i	CA 1386	CA 1387
↗ cm	77 x 62 x 97(h) cm	110 x 62 x 97(h) cm
N.	2	
MAX Kg	100 Kg	
	290 €	385 €

Carrelli di servizio in acciaio inox per sbarazzo
Stainless steel service trolleys for disposal

CA 1430



CA 1431



CA 1432



IT Carrelli di servizio inox per trasporto pesante. Struttura tubolare tonda \varnothing 25 mm, in acciaio inox **AISI 304** - ripiani in acciaio inox **AISI 304**, stampati in forma di vassoio con bordi arrotondati e alto spessore, insonorizzati e con finitura satinata - paracolpi in gomma - ruote multidirezionali \varnothing 125 mm.





EN Stainless steel service trolleys for heavy transport. Tubular structure \varnothing 25 mm in stainless steel **AISI 304** - **AISI 304** stainless steel shelves, tray-shaped with rounded edges and high thickness, soundproofed and with satin finish - rubber shock absorber - multidirectional wheels \varnothing 125 mm.

FR Chariots de service inox pour le transport de poids. Structure tubulaire ronde \varnothing 25 mm en acier inox **AISI 304** - étagères en acier inox **AISI 304**, moulées en forme de plateau à bords arrondis et de grande épaisseur, insonorisées et satinées - butoirs en caoutchouc - roues multidirectionnelles \varnothing 125 mm.

DE Servicewagen aus Edelstahl für Schwerlasten. Runder Rohrrahmen \varnothing 25 mm, aus Edelstahl **AISI 304** - Schallgedämmte Ablageflächen aus Edelstahl **AISI 304**, Tablett förmig bedruckt mit abgerundeten Kanten und satinierter Oberfläche - Gummistoßschutz- Mehrwegräder \varnothing 125 mm.

CA 1433



	CA 1430	CA 1431	CA 1432	CA 1433
 cm	110 x 60 x 100(h) cm		110 x 60 x 130(h) cm	110 x 60 x 160(h) cm
 N.	2	3	4	5
 mm	100 x 50 cm			
 MAX Kg	150 Kg			
	585 €	710 €	880 €	1.010 €

A 517

Ruote con freno - Wheels with catch
Roues avec frein - Räder mit Bremse

14 € cad./each

CA 1392P - CA 1393P



CA 1393P

A 514
Ruote con freno - Wheels with catch Roues avec frein - Räder mit Bremse
16 € cad./each

IT Carrelli di servizio inox per trasporto pesante. Struttura tubolare in acciaio inox **AISI 304** 25x25 mm - ripiani in acciaio inox **AISI 304**, piegati con omega di rinforzo, satinati e insonorizzati - paracolpi in gomma - ruote multidirezionali ø 125 mm.

EN Stainless steel service trolleys for heavy transport. Tubular structure 25x25 mm in stainless steel **AISI 304** - **AISI 304** stainless steel, folded shelves with support omega, satin-finished and soundproofed - rubber shock absorber - multidirectional wheels ø 125 mm.

FR Chariots de service inox pour le transport de poids. Structure tubulaire 25x25 mm en acier inox **AISI 304** - étagères en acier inox **AISI 304** pliées avec renforcement oméga, satinées et insonorisées - butoirs en caoutchouc - roues multidirectionnelles ø 125 mm.

DE Servicewagen aus Edelstahl für Schwerlasten. Rohrrahmen 25x25 mm aus Edelstahl **AISI 304** - mit Omega Verstärkung gebogene, schallgedämmte Ablageflächen aus Edelstahl **AISI 304** mit satiniertes Oberfläche - Gummistoßschutz - Mehrwegräder ø 125 mm.

	CA 1392P	CA 1393P
	92 x 67 x 98(h) cm	112 x 67 x 98(h) cm
	2	
	80 x 60 cm	100 x 60 cm
	200 Kg	
	550 €	580 €

CA 1394P - CA 1395P



CA 1395P

	CA 1394P	CA 1395P
	92 x 67 x 98(h) cm	112 x 67 x 98(h) cm
	3	
	80 x 60 cm	100 x 60 cm
	200 Kg	
	745 €	800 €

CP 1008 - CP 1010



WARNING



IT Carrelli di servizio multiuso in plastica con montanti in alluminio anodizzato.



EN Multipurpose plastic service trolleys with anodised aluminium uprights.

FR Chariots polyvalente en plastique avec montants en aluminium anodisé.

DE Mehrzweck-Servicewagen aus Kunststoff mit Trägern aus eloxiertem Aluminium.



Il carrello in foto è con optional A1001 e A1002
The trolley shown is equipped with optionals A1001 and A1002
Le chariot illustré est équipé avec A1001 et A1002
Der abgebildete Wagen ist mit A1001 und A1002ausgestattet

	CP 1008	CP 1010
	85 x 43 x 95(h) cm	102 x 50 x 96(h) cm
	3	
	40 Kg	
	95 €	180 €

	A 1001	A 1002
	23,5 x 33,5 x 18(h) cm	23 x 36,5 x 50,5(h) cm
	Cestino piccolo / Small basket Petit panier / Klein Korb	Cestino grande / Big basket Grand panier / Gros Korb
	10 €	25 €





Carrelli ed Espositori refrigerati e termici in legno

WOODEN REFRIGERATED
AND HEATED TROLLEYS AND DISPLAYS
CHARIOTS ET PRÉSENTOIRS
EN BOIS RÉFRIGÉRÉS ET THERMIQUES
KÜHL- UND HEIZWAGEN
UND -DISPLAYS AUS HOLZ

CLR 2788N

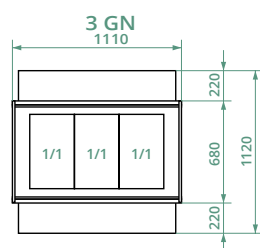
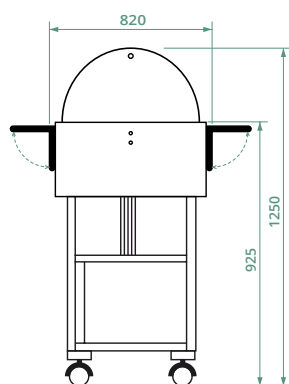
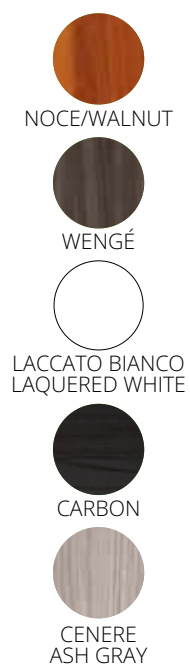

CLR 2788NBT CA

IT Carrelli refrigerati in legno con cupola in plexiglass. Struttura in legno multistrato di betulla - cupola semicircolare in plexiglass - refrigerazione statica - modelli con 2 mensole ripieghevoli - ruote \varnothing 75 mm di cui due con freno. Bacinelle escluse - le temperature di lavoro indicate sono da considerarsi con coperchi posizionati.

EN Wooden refrigerated trolleys with Plexiglas dome. Multi-layered birch wood structure - half-round Plexiglas dome - static refrigeration - two foldable shelves models - \varnothing 75 mm wheels, two of which with brakes. Basins excluded - the indicated working temperatures are to be considered with positioned lids.

FR Chariots réfrigérés en bois avec clochette en plexiglas. Structure en multicouche de bouleau - clochette en plexiglas semi-circulaire - réfrigération statique - modèles avec 2 étagères escamotables - roues de \varnothing 75 mm, dont deux avec freins. Bacs non compris - les températures de travail indiquées sont à considérer avec couvercles en place.

DE Kühlwagen aus Holz mit Plexiglashaube. Birkensperrholzstruktur - halbrunde Plexiglashaube - statische Kühlung - Modelle mit 2 Faltflächen - räder \varnothing 75 mm, davon zwei mit Bremsen. Behälter nicht enthalten - die angegebenen Arbeitstemperaturen sind bei aufgesetzten Deckeln zu verstehen.

	CLR311 Vasca inox forata - Stainless steel perforated container Bac inox perforée - Behälter aus rostfreiem Stahl mit löcher			
	3 x GN1/1 - 100(h) mm			
	210 €			
	CLR 2788N noce-walnut	CLR 2788N B laccato bianco laquered white	CLR 2788NBT noce-walnut	CLR 2788NBT B laccato bianco laquered white
	CLR 2788N W wengé		CLR 2788NBT W wengé	
	CLR 2788N CA carbon		CLR 2788NBT CA carbon	
	CLR 2788N CE cenere-ash gray		CLR 2788NBT CE cenere-ash gray	
	220-240V/1N/50 Hz			
	+2°C +10°C		-5°C +5°C	
	R600a			
	3 x GN1/1 - 150(h) mm			
	3.450 €	3.690 €	3.770 €	4.010 €

Carrelli refrigerati in legno
Wooden refrigerated trolleys

CLR 2787N

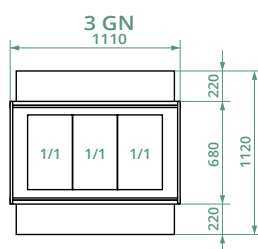
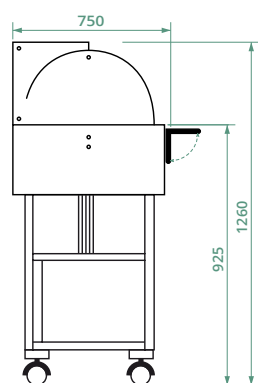
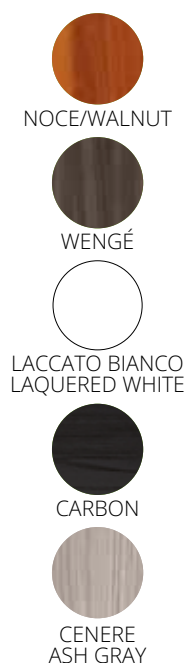

CLR 2787NBT

IT Carrelli refrigerati in legno con cupola in plexiglass. Struttura in legno multistrato di betulla - cupola semicircolare in plexiglass - refrigerazione statica - modelli disponibili con 1 mensola ripieghevole e 1 piano di appoggio - ruote \varnothing 75 mm di cui due con freno. Bacinelle escluse - le temperature di lavoro indicate sono da considerarsi con coperchi posizionati.

EN Wooden refrigerated trolleys with Plexiglas dome. Multi-layered birch wood structure - half-round Plexiglas dome - static refrigeration - models with foldable shelf and support base - \varnothing 75 mm wheels, two of which with brakes. Containers not included - the operating temperatures listed are to be considered with lids on.

FR Chariots réfrigérés en bois avec clochette en plexiglas. Structure en multicouche de bouleau - clochette en plexiglas semi-circulaire - réfrigération statique - modèles avec 1 étagère et plan de travail - roues de \varnothing 75 mm, dont deux avec freins. Bacs non compris - les températures de travail indiquées sont à considérer avec couvercles en place.

DE Kühlwagen aus Holz mit Plexiglashaube. Birkensperrholzstruktur - halbrunde Plexiglashaube - statische Kühlung - Modelle mit 1 Faltfläche und 1 Ablagefläche - räder \varnothing 75 mm, davon zwei mit Bremsen. Behälter nicht enthalten - die angegebenen Arbeitstemperaturen sind bei aufgesetzten Deckeln zu verstehen.

	CLR311 Vasca inox forata - Stainless steel perforated container Bac inox perforée - Behälter aus rostfreiem Stahl mit löcher
	3 x GN1/1 - 100(h) mm
	210 €

	CLR 2787N noce-walnut	CLR 2787NBT noce-walnut		
	CLR 2787N W wengé	CLR 2787N B laccato bianco laquered white	CLR 2787NBT W wengé	CLR 2787NBT B laccato bianco laquered white
	CLR 2787N CA carbon		CLR 2787NBT CA carbon	
	CLR 2787N CE cenere-ash gray		CLR 2787NBT CE cenere-ash gray	
	220-240V/1N/50 Hz			
	+2°C +10°C		-5°C +5°C	
	R600a			
	3 x GN1/1 - 150(h) mm			
	3.450 €	3.690 €	3.770 €	4.010 €

CLR 2786N

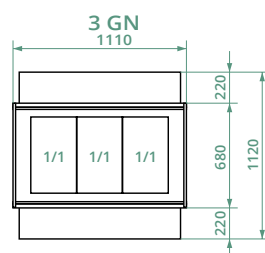
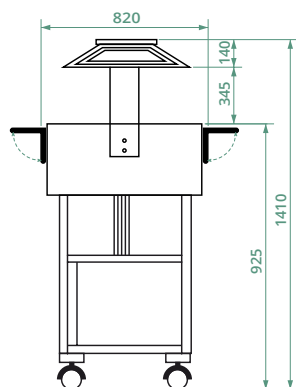
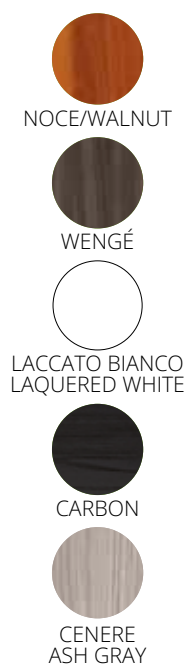

IT Carrelli refrigerati in legno con luce al neon. Struttura in legno multistrato di betulla - cupola in plexiglass - refrigerazione statica - 2 mensole ripieghevoli - 1 luce al neon - ruote \varnothing 75 mm di cui due con freno. Bacinelle escluse - le temperature di lavoro indicate sono da considerarsi con coperchi posizionati.

EN Refrigerated wooden trolleys with neon light. Multi-layered birch wood structure - half-round Plexiglas dome - static refrigeration - 2 foldable shelves - 1 neon light - \varnothing 75 mm wheels, two of which with brakes. Containers not included - the operating temperatures listed are to be considered with lids on.

FR Chariots réfrigérés en bois avec lampe néon. Structure en multicouche de bouleau - clochette en plexiglas - réfrigération statique - 2 étagères escamotables - 1 lampe néon - roues de \varnothing 75 mm, dont deux avec freins. Bacs non compris - les températures de travail indiquées sont à considérer avec couvercles en place.

DE Kühlwagen aus Holz mit Neonlampe. Birkensperrholzstruktur - Plexiglashaube - statische Kühlung - 2 faltflächen - 1 Neonlampe - räder \varnothing 75 mm, davon zwei mit Bremsen. Behälter nicht enthalten - die angegebenen Arbeitstemperaturen sind bei aufgesetzten Deckeln zu verstehen.

	CLR311 Vasca inox forata - Stainless steel perforated container Bac inox perforée - Behälter aus rostfreiem Stahl mit löcher
	3 x GN1/1 - 100(h) mm
	210 €

	CLR 2786N noce-walnut	CLR 2786NBT noce-walnut		
	CLR 2786N W wengé	CLR 2786N B laccato bianco laquered white	CLR 2786NBT W wengé	CLR 2786NBT B laccato bianco laquered white
	CLR 2786N CA carbon		CLR 2786NBT CA carbon	
	CLR 2786N CE cenere-ash gray		CLR 2786NBT CE cenere-ash gray	
	220-240V/1N/50 Hz			
	+2°C +10°C		-5°C +5°C	
	R600a			
	3 x GN1/1 - 150(h) mm			
	3.640 €	3.880 €	3.960 €	4.200 €

Carrelli refrigerati in legno
Wooden refrigerated trolleys

ELR 2827

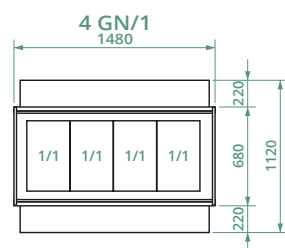
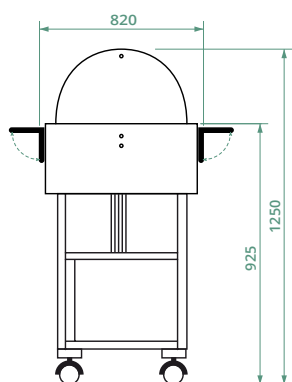
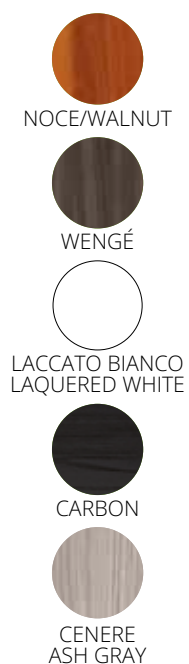

ELR 2827

IT Espositori refrigerati in legno con cupola. Struttura in legno multistrato di betulla - cupola semicircolare in plexiglass - refrigerazione statica - disponibili con 2 mensole ripieghevoli - ruote \varnothing 75 mm di cui due con freno. Bacinelle escluse - le temperature di lavoro indicate sono da considerarsi con coperchi posizionati.

EN Refrigerated wooden displays with dome. Multi-layered birch wood structure - half-round Plexiglas dome - static refrigeration - two foldable shelves models - \varnothing 75 mm wheels, two of which with brakes. Containers not included - the operating temperatures listed are to be considered with lids on.

FR Présentoirs réfrigérés en bois avec clochette. Structure en multicouche de bouleau - clochette en plexiglas semi-circulaire - réfrigération statique - modèles avec 2 étagères escamotables - roues de \varnothing 75 mm, dont deux avec freins. Bacs non compris - les températures de travail indiquées sont à considérer avec couvercles en place.

DE Kühlvitriren aus Holz mit Haube. Birkensperrholzstruktur - halbrunde Plexiglashaube - statische Kühlung - 2 Falflächen - räder \varnothing 75 mm, davon zwei mit Bremsen. Behälter nicht enthalten - die angegebenen Arbeitstemperaturen sind bei aufgesetzten Deckeln zu verstehen.

	CF411 Vasca inox forata - Stainless steel perforated container Bac inox perforée - Behälter aus rostfreiem Stahl mit löcher			
	4 x GN1/1 - 100(h) mm			
	250 €			
	ELR 2827 noce-walnut	ELR 2827 B laccato bianco laquered white	ELR 2827BT noce-walnut	ELR 2827BT B laccato bianco laquered white
	ELR 2827 W wengé		ELR 2827BT W wengé	
	ELR 2827 CA carbon		ELR 2827BT CA carbon	
	ELR 2827 CE cenere-ash gray		ELR 2827BT CE cenere-ash gray	
	220-240V/1N/50 Hz			
	+2°C +10°C		-5°C +5°C	
	R600a			
	4 x GN1/1 - 150(h) mm			
	3.585 €	3.825 €	3.905 €	4.145 €

ELR 2826

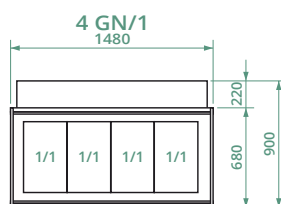
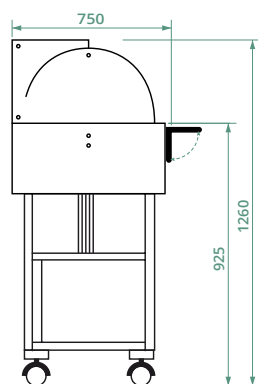
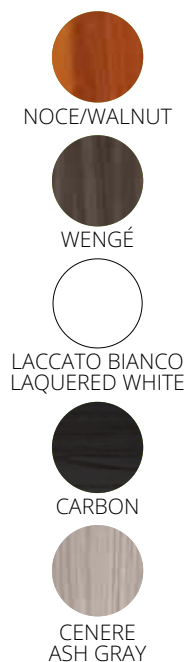

ELR 2826BT W

IT Espositori refrigerati in legno con cupola. Struttura in legno multistrato di betulla - cupola semicircolare in plexiglass - refrigerazione statica - disponibili con 1 mensola ripieghevole e 1 piano di appoggio - ruote \varnothing 75 mm di cui due con freno. Bacinelle escluse - le temperature di lavoro indicate sono da considerarsi con coperchi posizionati.

EN Refrigerated wooden displays with dome. Multi-layered birch wood structure - half-round Plexiglas dome - static refrigeration - models with 1 foldable shelf and 1 support base - \varnothing 75 mm wheels, two of which with brakes. Containers not included - the operating temperatures listed are to be considered with lids on.

FR Présentoirs réfrigérés en bois avec clochette. Structure en multicouche de bouleau - clochette en plexiglas semi-circulaire - réfrigération statique - avec 1 étagère escamotable et plan de travail - roues de \varnothing 75 mm, dont deux avec freins. Bacs non compris - les températures de travail indiquées sont à considérer avec couvercles en place.

DE Kühlvitrinen aus Holz mit Haube. Birkensperrholzstruktur - halbrunde Plexiglashaube - statische Kühlung - Modelle mit 1 faltfläche und 1 Ablagefläche - räder \varnothing 75 mm, davon zwei mit Bremsen. Behälter nicht enthalten - die angegebenen Arbeitstemperaturen sind bei aufgesetzten Deckeln zu verstehen.

	CF411 Vasca inox forata - Stainless steel perforated container Bac inox perforée - Behälter aus rostfreiem Stahl mit löcher			
	4 x GN1/1 - 100(h) mm			
	250 €			
	ELR 2826 noce-walnut	ELR 2826 B laccato bianco laquered white	ELR 2826BT noce-walnut	ELR 2826BT B laccato bianco laquered white
	ELR 2826 W wengé		ELR 2826BT W wengé	
	ELR 2826 CA carbon		ELR 2826BT CA carbon	
	ELR 2826 CE cenere-ash gray		ELR 2826BT CE cenere-ash gray	
	220-240V/1N/50 Hz			
	+2°C +10°C		-5°C +5°C	
	R600a			
	4 x GN1/1 - 150(h) mm			
	3.585 €	3.825 €	3.905 €	4.145 €

Espositori refrigerati in legno
Wooden refrigerated displays

ELR 2825

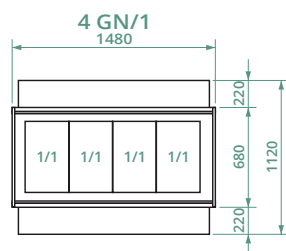
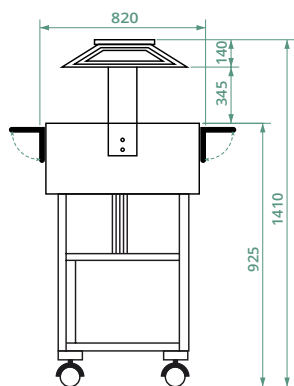
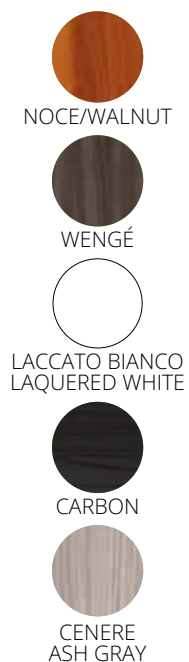

ELR 2825 W

IT Espositori refrigerati in legno con luce al neon. Struttura in legno multistrato di betulla - cupola in plexiglass - refrigerazione statica - 2 mensole ripieghevoli - 1 luce al neon - ruote \varnothing 75 mm di cui due con freno. Bacinelle escluse - le temperature di lavoro indicate sono da considerarsi con coperchi posizionati.

EN Refrigerated wooden displays with neon light. Multi-layered birch wood structure - Plexiglas dome - static refrigeration - 2 foldable shelves - 1 neon light - \varnothing 75 mm wheels, two of which with brakes. Containers not included - the operating temperatures listed are to be considered with lids on.

FR Présentoirs réfrigérés en bois avec lampe néon. Structure en multicouche de bouleau - clochette en plexiglas - réfrigération statique - 2 étagères escamotables - 1 lampe néon - roues de \varnothing 75 mm, dont deux avec freins. Bacs non compris - les températures de travail indiquées sont à considérer avec couvercles en place.

DE Kühlvitrinen aus Holz mit Neonlampe. Birkensperrholzstruktur - Plexiglashaube - statische Kühlung - 2 faltflächen - 1 Neonlampe - räder \varnothing 75 mm, davon zwei mit Bremsen. Behälter nicht enthalten - die angegebenen Arbeitstemperaturen sind bei aufgesetzten Deckeln zu verstehen.

	CF411 Vasca inox forata - Stainless steel perforated container Bac inox perforée - Behälter aus rostfreiem Stahl mit löcher
	4 x GN1/1 - 100(h) mm
	250 €

	ELR 2825 noce-walnut	ELR 2825BT noce-walnut	ELR 2825BT W wengé	ELR 2825BT B laccato bianco laquered white
	ELR 2825 W wengé	ELR 2825 B laccato bianco laquered white	ELR 2825BT CA carbon	ELR 2825BT B laccato bianco laquered white
	ELR 2825 CA carbon	ELR 2825 CE cenere-ash gray	ELR 2825BT CE cenere-ash gray	
	220-240V/1N/50 Hz			
	+2°C +10°C		-5°C +5°C	
	R600a			
	4 x GN1/1 - 150(h) mm			
	3.800 €	4.040 €	4.120 €	4.360 €

CL 2777N

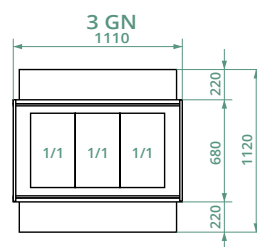
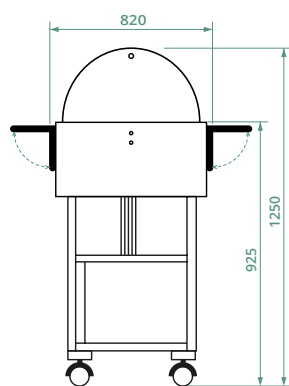
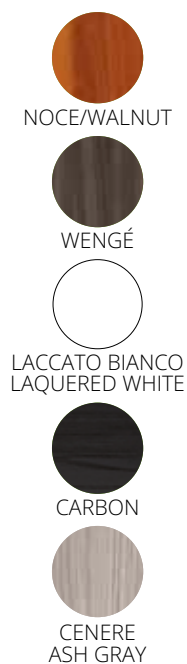

IT Carrelli termici a bagnomaria in legno, con cupola. Struttura in legno multistrato di betulla - cupola semicircolare in plexiglass - riscaldato con resistenza elettrica - disponibili con 2 mensole ripieghevoli - ruote \varnothing 75 mm di cui due con freno. Bacinelle escluse - le temperature di lavoro indicate sono da considerarsi con coperchi posizionati.

EN Wooden heated bain-marie trolleys with dome. Multi-layered birch wood structure - half-round Plexiglas dome - electric heating element - available with two foldable shelves - \varnothing 75 mm wheels, two of which with brakes. Containers not included - the operating temperatures listed are to be considered with lids on.

FR Chariots bain-marie chauffants en bois avec clochette. Structure en multicouche de bouleau - clochette en plexiglas semi-circulaire - chauffé par résistance électrique - disponibles avec 2 étagère escamotable - roues de \varnothing 75 mm, dont deux avec freins. Bacs non compris - les températures de travail indiquées sont à considérer avec couvercles en place.

DE Bain-Marie Heizwagen aus Holz mit Haube. Birkensperrholzstruktur - halbrunde Plexiglashaube - mit elektrischem Heizstab beheizt - mit 2 Faltflächen - räder \varnothing 75 mm, davon zwei mit Bremsen. Behälter nicht enthalten - die angegebenen Arbeitstemperaturen sind bei aufgesetzten Deckeln zu verstehen.

i	CL 2777N noce-walnut	CL 2777N B laccato bianco laquered white
	CL 2777N W wengé	
	CL 2777N CA carbon	
	CL 2777N CE cenere-ash gray	
⚡	2000 W	
🔌 1 Ph	220-240V/1N/50 Hz	
🌡️	+30°C +90°C	
🍲	3 x GN1/1 - 150(h) mm	
	2.650 €	2.830 €

Carrelli termici a bagnomaria in legno
Wooden bain-marie trolleys

CL 2778N

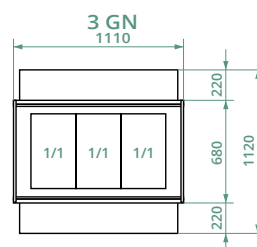
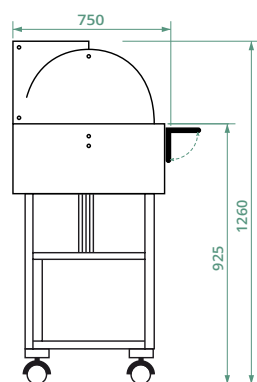
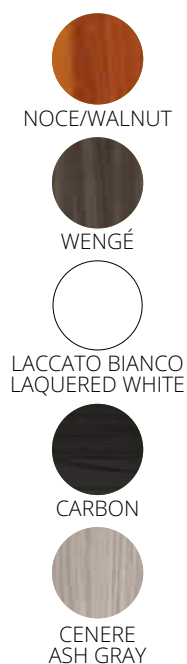

CL 2778 N

IT Carrelli termici a bagnomaria in legno, con cupola. Struttura in legno multistrato di betulla - cupola semicircolare in plexiglass - riscaldato con resistenza elettrica - disponibili con 1 mensola ripieghevole e 1 piano di appoggio - ruote \varnothing 75 mm di cui due con freno. Bacinelle escluse - le temperature di lavoro indicate sono da considerarsi con coperchi posizionati.

EN Wooden heated bain-marie trolleys with dome. Multi-layered birch wood structure - half-round Plexiglas dome - electric heating element - available with 1 foldable shelf and 1 support base - \varnothing 75 mm wheels, two of which with brakes. Containers not included - the operating temperatures listed are to be considered with lids on.

FR Chariots bain-marie chauffants en bois avec clochette. Structure en multicouche de bouleau - clochette en plexiglas semi-circulaire - chauffé par résistance électrique - disponibles avec 1 étagère escamotable et 1 plan de travail - roues de \varnothing 75 mm, dont deux avec freins. Bacs non compris - les températures de travail indiquées sont à considérer avec couvercles en place.

DE Bain-Marie Heizwagen aus Holz mit Haube. Birkensperrholzstruktur - halbrunde Plexiglashaube - mit elektrischem Heizstab beheizt - mit 1 Faltfläche und 1 Ablagefläche - räder \varnothing 75 mm, davon zwei mit Bremsen. Behälter nicht enthalten - die angegebenen Arbeitstemperaturen sind bei aufgesetzten Deckeln zu verstehen.

	CL 2778N noce-walnut	CL 2778N B laccato bianco laquered white
	CL 2778N W wengé	
	CL 2778N CA carbon	
	CL 2778N CE cenere-ash gray	
	2000 W	
 1 Ph	220-240V/1N/50 Hz	
	+30°C +90°C	
	3 x GN1/1 - 150(h) mm	
	2.630 €	2.810 €

CL 2774N

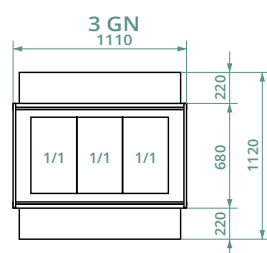
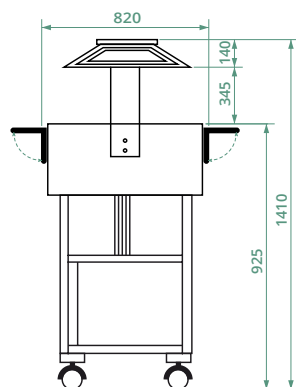
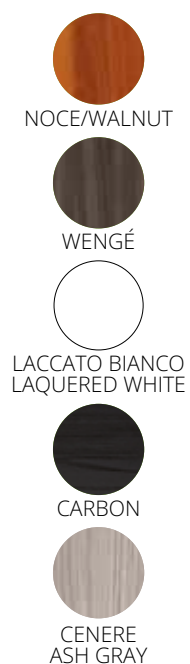

IT Carrelli termici a bagnomaria in legno, da buffet. Struttura in legno multistrato di betulla - cupola in plexiglass - luce al neon - riscaldato con resistenza elettrica - disponibili con 2 mensole ripieghevoli - ruote \varnothing 75 mm di cui due con freno. Bacinelle escluse - le temperature di lavoro indicate sono da considerarsi con coperchi posizionati.

EN Wooden heated bain-marie trolleys, for buffet. Multi-layered birch wood structure - half-round Plexiglas dome - neon light - electric heating element - available with 2 foldable shelves - \varnothing 75 mm wheels, two of which with brakes. Containers not included - the operating temperatures listed are to be considered with lids on.

FR Chariots bain-marie chauffants en bois, pour buffet. Structure en multicouche de bouleau - clochette en plexiglas - lampe néon - chauffé par résistance électrique - disponibles avec 2 étagères escamotables - roues de \varnothing 75 mm, dont deux avec freins. Bacs non compris - les températures de travail indiquées sont à considérer avec couvercles en place.

DE Bain-Marie Heizwagen aus Holz für Buffets. Birkensperrholzstruktur - Plexiglashaube - Neonlampe - mit elektrischem Heizstab beheizt - mit 2 Faltflächen - räder \varnothing 75 mm, davon zwei mit Bremsen. Behälter nicht enthalten - die angegebenen Arbeitstemperaturen sind bei aufgesetzten Deckeln zu verstehen.

	CL 2774N noce-walnut	CL 2774N B laccato bianco laquered white
	CL 2774N W wengé	
	CL 2774N CA carbon	
	CL 2774N CE cenere-ash gray	
	2000 W	
 1 Ph	220-240V/1N/50 Hz	
	+30°C +90°C	
	3 x GN1/1 - 150(h) mm	
	2.840 €	3.020 €

Carrelli termici a bagnomaria in legno
Wooden heated bain-marie trolleys

ELC 2832

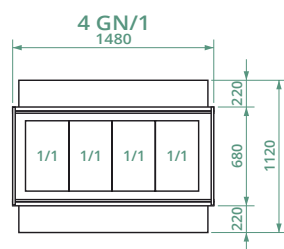
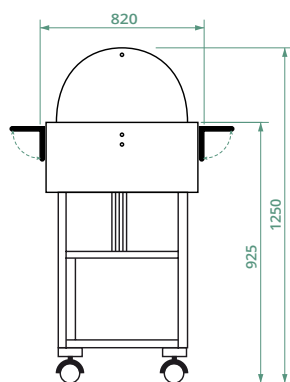
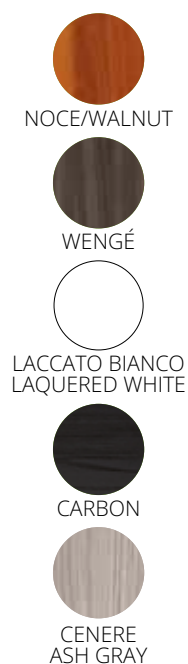

ELC 2832 CE

IT Espositore termico a bagnomaria in legno, con cupola. Struttura in legno multistrato di betulla - cupola semicircolare in plexiglass - riscaldato con resistenza elettrica - disponibili con 2 mensole ripieghevoli - ruote \varnothing 75 mm di cui due con freno. Bacinelle escluse - le temperature di lavoro indicate sono da considerarsi con coperchi posizionati.

EN Wooden heated bain-marie display with dome. Multi-layered birch wood structure - half-round Plexiglas dome - electric heating element - available with two foldable shelves - \varnothing 75 mm wheels, two of which with brakes. Containers not included - the operating temperatures listed are to be considered with lids on.

FR Présentoir bain-marie chauffants en bois avec clochette. Structure en multicouche de bouleau - clochette en plexiglas semi-circulaire - chauffé par résistance électrique - disponibles avec 2 étagères escamotables - roues de \varnothing 75 mm, dont deux avec freins. Bacs non compris - les températures de travail indiquées sont à considérer avec couvercles en place.

DE Bain-Marie Heizvitrine aus Holz mit Haube. Birkensperrholzstruktur - halbrunde Plexiglashaube - mit elektrischem Heizstab beheizt - mit 2 Faltflächen - räder \varnothing 75 mm, davon zwei mit Bremsen. Behälter nicht enthalten - die angegebenen Arbeitstemperaturen sind bei aufgesetzten Deckeln zu verstehen.

i	ELC 2832 noce-walnut	ELC 2832 B laccato bianco laquered white
	ELC 2832 W wengé	
	ELC 2832 CA carbon	
	ELC 2832 CE cenere-ash gray	
⚡	2000 W	
🔌 1 Ph	220-240V/1N/50 Hz	
🌡️	+30°C +90°C	
N.	4 x GN1/1 - 150(h) mm	
	2.770 €	2.950 €

ELC 2834

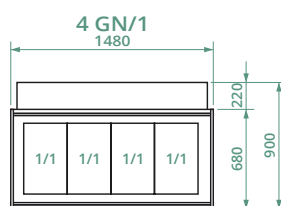
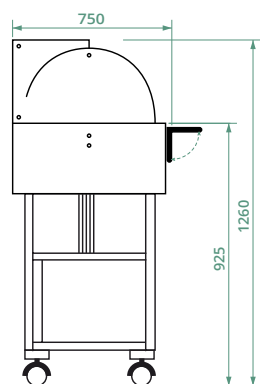
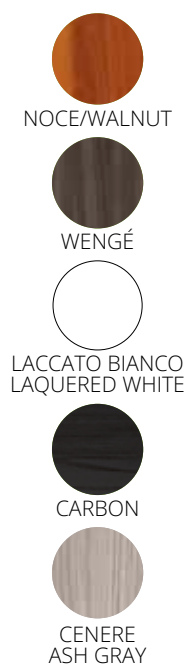

ELC 2834 B

IT Espositore termico a bagnomaria in legno, con cupola. Struttura in legno multistrato di betulla - cupola semicircolare in plexiglass - riscaldato con resistenza elettrica - disponibili con 1 mensola ripieghevole e 1 piano di appoggio - ruote \varnothing 75 mm di cui due con freno. Bacinelle escluse - le temperature di lavoro indicate sono da considerarsi con coperchi posizionati.

EN Wooden heated bain-marie display with dome. Multi-layered birch wood structure - half-round Plexiglas dome - electric heating element - available with 1 foldable shelf and 1 support base - \varnothing 75 mm wheels, two of which with brakes. Containers not included - the operating temperatures listed are to be considered with lids on.

FR Présentoir bain-marie chauffants en bois avec clochette. Structure en multicouche de bouleau - clochette en plexiglas semi-circulaire - chauffé par résistance électrique - disponibles avec 1 étagère escamotable et 1 plan de travail - roues de \varnothing 75 mm, dont deux avec freins. Bacs non compris - les températures de travail indiquées sont à considérer avec couvercles en place.

DE Bain-Marie Heizvitrine aus Holz mit Haube. Birkensperrholzstruktur - halbrunde Plexiglashaube - mit elektrischem Heizstab beheizt - mit 1 Faltofläche und 1 Ablagefläche - räder \varnothing 75 mm, davon zwei mit Bremsen. Behälter nicht enthalten - die angegebenen Arbeitstemperaturen sind bei aufgesetzten Deckeln zu verstehen.

i	ELC 2834 noce-walnut	ELC 2834 B laccato bianco laquered white
	ELC 2834 W wengé	
	ELC 2834 CA carbon	
	ELC 2834 CE cenere-ash gray	
⚡	2000 W	
1 Ph	220-240V/1N/50 Hz	
🌡️	+30°C +90°C	
N.	4 x GN1/1 - 150(h) mm	
	2.980 €	3.160 €

Espositori termici a bagnomaria in legno
Wooden heated bain-marie displays

ELC 2828

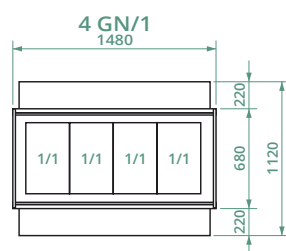
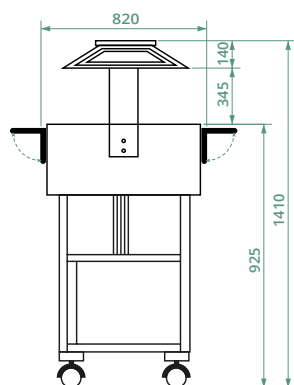
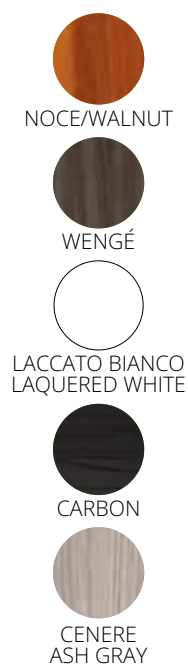

ELC 2828

IT Espositore termico a bagnomaria in legno, con luce al neon. Struttura in legno multistrato di betulla - cupola in plexiglass - luce al neon - riscaldato con resistenza elettrica - disponibili con 2 mensole ripieghevoli - ruote \varnothing 75 mm di cui due con freno. Bacinelle escluse - le temperature di lavoro indicate sono da considerarsi con coperchi posizionati.

EN Wooden heated bain-marie display with neon light. Multi-layered birch wood structure - half-round Plexiglas dome - neon light - electric heating element - available with 2 foldable shelves - \varnothing 75 mm wheels, two of which with brakes. Containers not included - the operating temperatures listed are to be considered with lids on.

FR Présentoir bain-marie chauffants en bois, avec lampe néon. Structure en multicouche de bouleau - clochette en plexiglas - lampe néon - chauffé par résistance électrique - disponibles avec 2 étagères escamotables - roues de \varnothing 75 mm, dont deux avec freins. Bacs non compris - les températures de travail indiquées sont à considérer avec couvercles en place.

DE Bain-Marie Heizvitrine aus Holz mit Neonlampe. Birkensperrholzstruktur - Plexiglashaube - Neonlampe - mit elektrischem Heizstab beheizt - mit 2 Falflächen - räder \varnothing 75 mm, davon zwei mit Bremsen. Behälter nicht enthalten - die angegebenen Arbeitstemperaturen sind bei aufgesetzten Deckeln zu verstehen.

i	ELC 2828 noce-walnut	ELC 2828 B laccato bianco laquered white
	ELC 2828 W wengé	
	ELC 2828 CA carbon	
	ELC 2828 CE cenere-ash gray	
⚡	2000 W	
🔌 1 Ph	220-240V/1N/50 Hz	
🌡️	+30°C +90°C	
🍲 N.	4 x GN1/1 - 150(h) mm	
	2.995 €	3.175 €

CL 2770N

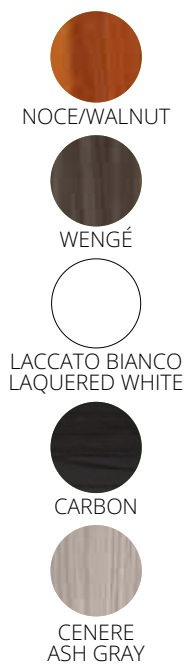

Solo per modello CL2770
For CL2770 model only

A 580	A 590
Portacoperchi inox Stainless steel lid holder Porte-couvercle en acier inox Edelstahl-Deckelhalter	Portacoltelli Knives holder Porte-couteaux Messerhalter
100 €	60 €
A 600	
Scorrevole portapiatti con tagliere polietilene Sliding plate holder with polyethylene chopping board Porte-plat coulissant avec planche en polyéthylène Gleitplattenhalter mit Polyethylen-Schneidebrett	
140 €	

IT Carrello termico in legno, ideale per bolliti e arrostiti. Struttura portante in legno multistrato di betulla - vasca in acciaio inox **AISI 304** munita di scarico. Bacinelle escluse. Immagine con optional A580/A590/A600.

EN Wooden heated trolley, ideal for boiled and roasted meats. Multi-layered birch wood structure - stainless steel **AISI 304** bowl with drain. Containers not included. Image with optional A580/A590/A600.

FR Chariot chauffant en bois, idéal pour les viandes bouillies et rôties. Structure portante en multicouche de bouleau - cuve en acier inox **AISI 304** avec vidange. Bacs non compris. Photo avec optional A580/A590/A600.

DE Heizwagen aus Holz, ideal für gekochtes und gebratenes Fleisch. Birkensperrholztragstruktur - Becken aus Edelstahl **AISI 304** mit Ablauf. Behälter nicht enthalten. Bild mit optional A580/A590/A600.

i	CL 2770N noce-walnut	CL 2770N B laccato bianco laquered white
	CL 2770N W wengé	
	CL 2770N CA carbon	
	CL 2770N CE cenere-ash gray	
⚡	2000 W	
⚡ 1 Ph	220-240V/1N/50 Hz	
🌡️	+30°C +90°C	
N.	3x GN1/1 150(h) mm	
↗️ cm	123 x 65 x 95(h) cm	
	2.040 €	2.220 €

Carrello termico, ideale per bolliti e arrostiti
Heated trolley, ideal for boiled and roasted meats

Mensole in legno per unione

CONNECTION WOODEN SHELF - ÉTAGÈRES EN BOIS POUR RACCORDS - VERBINDUNGSREGALE AUS HOLZ

MLUN



ANUN

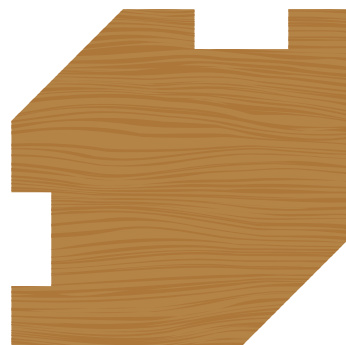

MLUNW

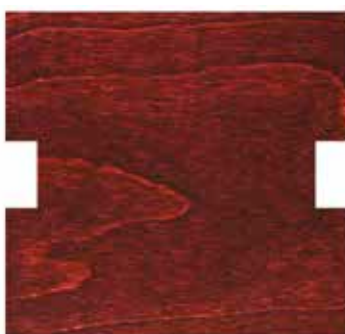

ANUNW



PER MODELLI / FOR MODEL

CLR 2786	ELR 2825	ELC 2828	CL 2774
CLR 2787	ELR 2826	ELC 2832	CL 2777
CLR 2788	ELR 2827	ELC 2834	CL 2778

i	MLUN	MLUNW	ANUN	ANUNW
↗ cm	68 x 70 cm		88 x 88 cm	
	170 €		210 €	

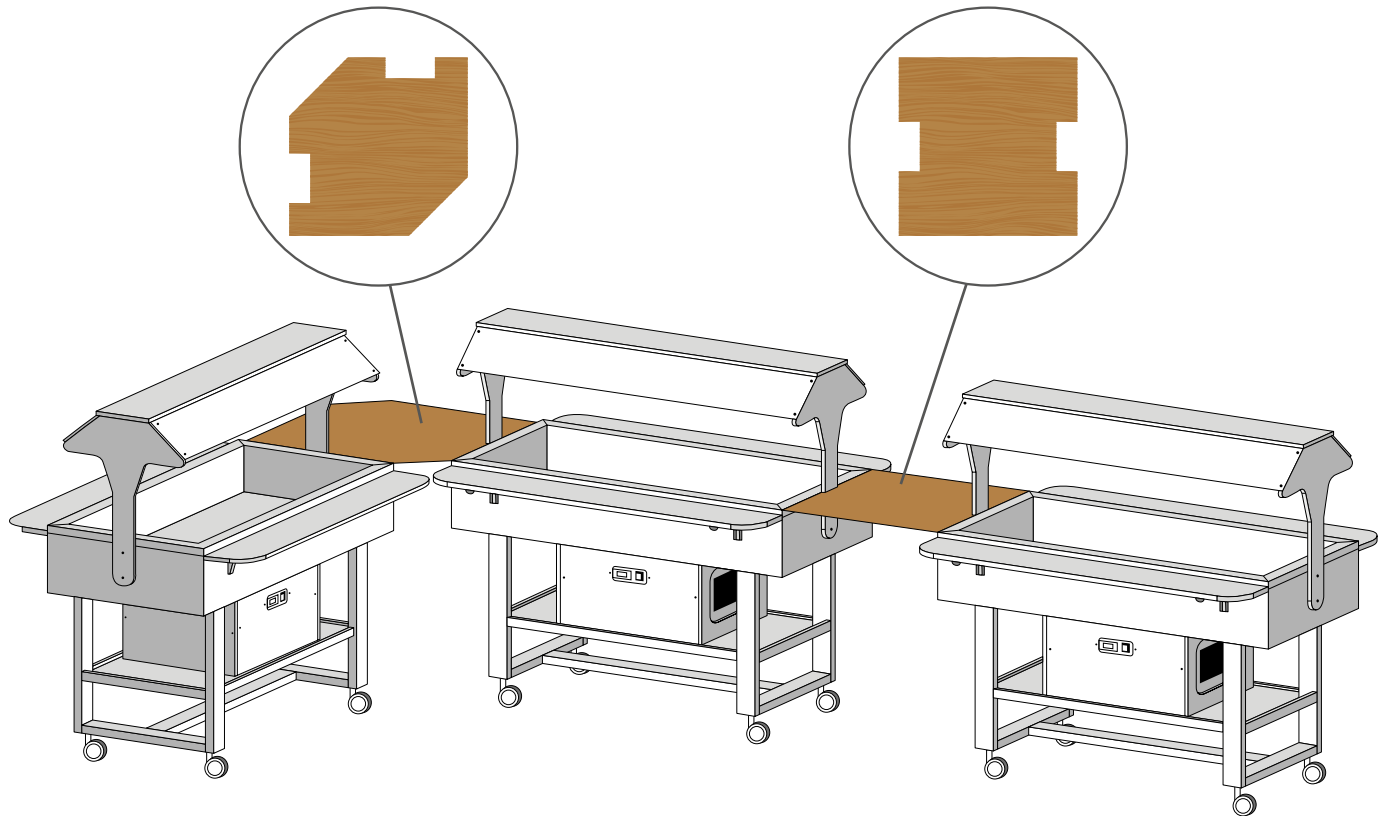
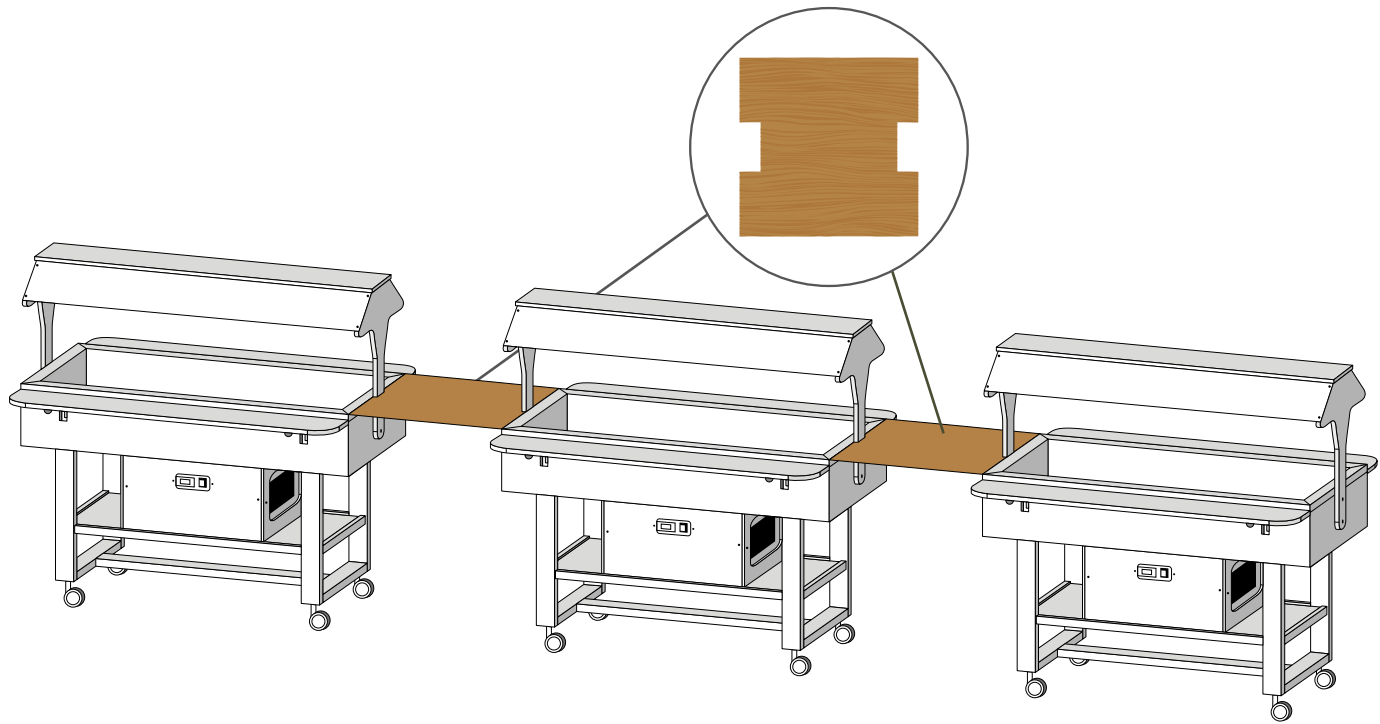



Carrelli, vasche e distributori in acciaio inox

STAINLESS STEEL TROLLEYS,
BOWLS AND DISPENSERS.
CHARIOTS, CUVES ET DISTRIBUTEURS
EN ACIER INOX
WAGEN, WANNEN UND SPENDER
AUS EDELSTAHL

G-VRI211 - G-VRI311 G-VRI411 - G-VRI311F G-VRI411F



IT Vasche refrigerate da incasso in acciaio inox **AISI 304**. Struttura in acciaio inox **AISI 304** - spessore isolamenti 50 mm - refrigerazione statica - gruppo incorporato nel vano inferiore - controllo temperatura elettronico con termostato digitale - sbrinatorio automatico - evaporazione dell'acqua di condensa automatica.

EN Stainless steel **AISI 304** refrigerated bowls. Stainless steel **AISI 304** structure - 50 mm insulation thickness - static refrigeration - built-in control unit in the lower compartment - electronic temperature control with digital thermostat - automatic defrosting - automatic evaporation of condensation water.

FR Cuves réfrigérées en acier inox **AISI 304**. Structure en acier inox **AISI 304** - épaisseur d'isolation de 50 mm - réfrigération statique - unité incorporée dans le compartiment inférieur - régulation électronique de température avec thermostat digital - dégivrage automatique - évaporation automatique de l'eau de condensation.

DE Kühlwannen aus Edelstahl **AISI 304**. Struktur aus Edelstahl **AISI 304** - 50 mm Isolierstärke - statische Kühlung - Einbaueinheit im unteren Fach - elektronische Temperaturregelung mit digitalem Thermostat - automatische Abtauung - automatische Kondensatverdampfung.

i	G-VRI211	G-VRI311	G-VRI411	G-VRI311F	G-VRI411F
⚡	340 W				
1 Ph	220-240V/1N/50 Hz				
🌡️	+2°C +8°C			-5°C +5°C	
N.	2 x GN1/1 - 150(h) mm	3 x GN1/1 - 150(h) mm	4 x GN1/1 - 150(h) mm	3 x GN1/1 - 150(h) mm	4 x GN1/1 - 150(h) mm
	1.420 €	1.495 €	1.600 €	1.840 €	1.980 €

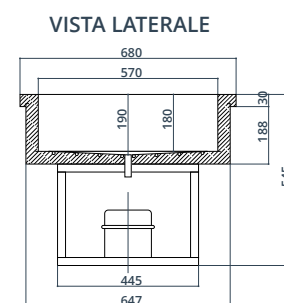
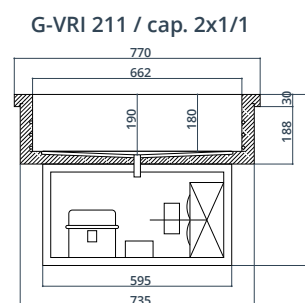
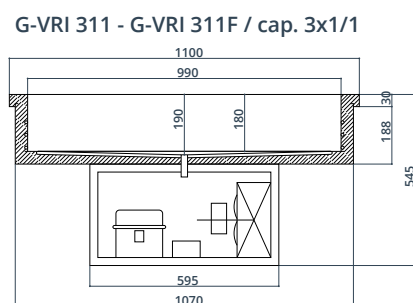
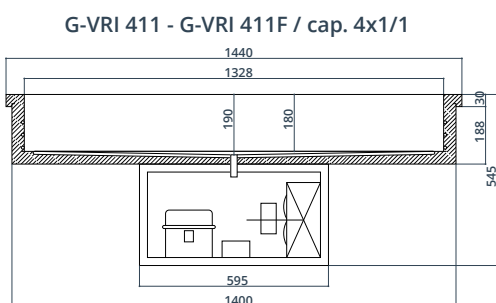

Vasche refrigerate in acciaio inox AISI 304 ad incasso
Recessed stainless steel AISI 304 refrigerated bowls

VBC 211
VBC 311
VBC 411



IT Vasche termiche da incasso a bagnomaria in acciaio inox **AISI 304**. Vasca dotata di scarico acqua - controllo temperatura elettronico con termostato digitale.

EN Stainless steel **AISI 304** heated Bain-marie bowls. Bowl with water drain - electronic temperature control with digital thermostat.

FR Cuves bain-marie en acier inox **AISI 304**. Cuve équipée de vidange d'eau - régulation électronique de la température avec thermostat digital.

DE Bain-Marie Heizwannen aus Edelstahl **AISI 304**. Wanne mit Wasserablauf - elektronische Temperaturregelung mit digitalem Thermostat.



CLR311	CF411
Griglia forata 3 x GN1/1 S/S perforated container 3 x GN1/1	Vasca inox forata 4 x GN1/1 S/S perforated container 4 x GN1/1
210 €	250 €

i	VBC 211	VBC 311	VBC 411
⚡	2000 W		
🔌 1 Ph	220-240V/1N/50 Hz		
🌡️	+30°C +90°C		
N.	2 x GN1/1 - 150(h) mm	3 x GN1/1 - 150(h) mm	4 x GN1/1 - 150(h) mm
	745 €	825 €	910 €

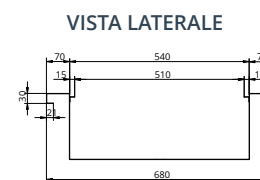
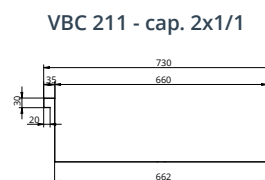
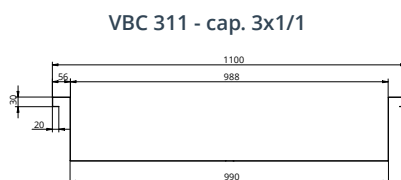
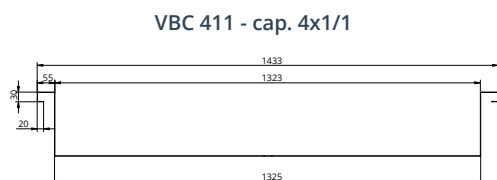

CAR 2779



IT Carrelli refrigerati in acciaio inox. Struttura in acciaio inox **AISI 304** - refrigerazione statica - maniglia direzionale - ruote multidirezionali ø 125 mm. Bacinelle escluse - le temperature di lavoro indicate sono da considerarsi con coperchi posizionati.

EN Stainless steel refrigerated trolleys. Stainless steel **AISI 304** structure - static refrigeration - directional handle - multidirectional wheels ø 125 mm. Containers not included - the operating temperatures listed are to be considered with lids on.

FR Chariots réfrigéré en acier inox. Structure en acier inox **AISI 304** - réfrigération statique - poignée directionnelle - roues multidirectionnelles ø 125 mm. Bacs non compris - les températures de travail indiquées sont à considérer avec couvercles en place.

DE Kühlwagen aus Edelstahl. Struktur Edelstahl **AISI 304** - statische Kühlung - Lenkgriff - Mehrwegräder ø 125 mm. Behälter nicht enthalten - die angegebenen Arbeitstemperaturen sind bei aufgesetzten Deckeln zu verstehen.

CAR 2780 - CAR 2780BT



CAR 2780

i	CAR 2779	CAR 2780	CAR 2780BT
⚡	250 W		
🔌 1 Ph	220-240V/1N/50 Hz		
🔥	R600a		
🌡️	+2°C +10°C	-5°C +5°C	
📏 N.	3 x GN1/1 - 150(h) mm		
↗️ cm	124 x 72 x 94(h) cm	124 x 72 x 126(h) cm	
	2.830 €	3.210 €	3.530 €

Carrelli refrigerati in acciaio inox AISI 304
Stainless steel AISI 304 refrigerated trolleys

CT 1760C









CT 1760C
CON CUPOLA SEMICIRCOLARE / WITH SEMICIRCULAR DOME

IT Carrelli termici a bagnomaria. Struttura in acciaio inox **AISI 304** - vasca a doppia parete provvista di rubinetto di scarico posto sul fondo - termostato regolabile - maniglia direzionale - paracolpi - ruote multidirezionali ø 125 mm. Bacinelle escluse - le temperature di lavoro indicate sono da considerarsi con coperchi posizionati.

EN Bain-marie heated trolleys. Stainless steel **AISI 304** structure - double walled bowl with drain valve fitted at the bottom - adjustable thermostat - directional handle - shock absorber - multidirectional wheels ø 125 mm. Containers not included - the operating temperatures listed are to be considered with lids on.

FR Chariots chauffantes bain-marie. Structure en acier inox **AISI 304** - cuve à double paroi équipée d'un robinet de vidange en bas - thermostat réglable - poignée directionnelle - butoirs - roues multidirectionnelles ø 125 mm. Bacs non compris - les températures de travail indiquées sont à considérer avec couvercles en place.

DE Bain-Marie Heizwagen Struktur aus Edelstahl **AISI 304** - Doppelwandige Wanne mit einem Ablasshahn im Unterteil - einstellbarer Thermostat - Lenkergriff - Stoßschutz - Mehrwegräder ø 125 mm. Behälter nicht enthalten - die angegebenen Arbeitstemperaturen sind bei aufgesetzten Deckeln zu verstehen.

	CT 1760C
	2000 W
 1 Ph	220-240V/1N/50-60 Hz
	+30° +90°C
	3 x GN1/1 - 200(h) mm
	117 x 67 x 114(h) cm
	1.720 €

CT 1758TD CT 1760TD





CT 1760TD

IT Carrelli termici a bagnomaria con temperature differenziate in acciaio inox **AISI 304**. Struttura in acciaio inox **AISI 304** - vasca a doppia parete provvista di rubinetto di scarico posto sul fondo - termostato regolabile - maniglia direzionale - paracolpi - ruote multidirezionali \varnothing 125 mm. Bacinelle escluse - le temperature di lavoro indicate sono da considerarsi con coperchi posizionati.

EN Stainless steel **AISI 304** Bain-marie heated trolleys with separate temperatures. Stainless steel **AISI 304** structure - double walled bowl with drain valve fitted at the bottom - adjustable thermostat - directional handle - shock absorber - multidirectional wheels \varnothing 125 mm. Containers not included - the operating temperatures listed are to be considered with lids on.

FR Chariots chauffantes bain-marie à températures différenciées en acier inox **AISI 304**. Structure en acier inox **AISI 304** - cuve à double paroi équipée d'un robinet de vidange en bas - thermostat réglable - poignée directionnelle - butoirs - roues multidirectionnelles \varnothing 125 mm. Bacs non compris - les températures de travail indiquées sont à considérer avec couvercles en place.

DE Bain-Marie Heizwagen mit unterschiedlichen Temperaturen aus Edelstahl **AISI 304**. Struktur aus Edelstahl **AISI 304** - Doppelwandige Wanne ausgestattet mit einem unten angebrachten Ablaufventil - einstellbarer Thermostat - Lenkergriff - Stoßschutz - Mehrwegräder \varnothing 125 mm. Behälter nicht enthalten - die angegebenen Arbeitstemperaturen sind bei aufgesetzten Deckeln zu verstehen.

	CT 1758TD	CT 1760TD
	2000 W	3000 W
 1 Ph	220-240V/1N/50-60 Hz	
	+30° +90°C	
	2 x GN1/1 - 150(h) mm	3 x GN1/1 - 150(h) mm
	84 x 65 x 85(h) cm	117 x 67 x 85(h) cm
	1.000 €	1.280 €

Carrelli termici a bagnomaria in acciaio inox AISI 304
Stainless steel AISI 304 bain-marie heated trolleys

CT 1765 CT 1770



CT 1765



CT 1770







IT Carrelli termici a bagnomaria armadiati. Struttura in acciaio inox **AISI 304** - vano superiore in doppia parete coibentata - coperchi apribili a compasso fino a 180° per formare un piano di appoggio - provvisti di rubinetto di scarico posto sul fondo - 2 ruote fisse e 2 multidirezionali ø 140 mm. Bacinelle escluse - le temperature di lavoro indicate sono da considerarsi con coperchi posizionati.

EN Bain-marie heated trolleys on counters. Structure in **AISI 304** stainless steel - insulated double-walled upper compartment - lids that can be opened up to 180° to form a support surface. Equipped with a drain valve on the bottom - 2 fixed wheels and 2 multidirectional wheels ø 140 mm. Containers not included - the operating temperatures listed are to be considered with lids on.

FR Chariots chauffants bain-marie sur meublé fermé. Structure en acier inox **AISI 304** - compartiment supérieur en double paroi isolée - couvercles pouvant s'ouvrir jusqu'à 180° pour former une surface d'appui - 2 roues fixes et 2 roues multidirectionnelles ø 140 mm, équipées d'un robinet de vidange placé en bas. Bacs non compris - les températures de travail indiquées sont à considérer avec couvercles en place.

DE Bain-Marie Heizwagen mit Schrankelement. Struktur aus Edelstahl **AISI 304** - oberes Fach mit isoliertem Doppelwand - Deckel bis zu 180° öffnungsfähig, um eine Auflagefläche zu bilden, ausgestattet mit einem unten angebrachten Ablaufventil - 2 feste Räder und 2 Mehrwegräder ø 140 mm. Behälter nicht enthalten - die angegebenen Arbeitstemperaturen sind bei aufgesetzten Deckeln zu verstehen.

A650 mod. CT 1765	A700 mod. CT 1770
Vano inferiore riscaldato - Heated lower compartment Compartiment inferieur chauffé - Beheiztes Unterfach	
270 €	

	CT 1765	CT 1770
	2000 W	
	220-240V/1N/50-60 Hz	
	+30° +90°C	
	2 x GN1/1 - 200(h) mm	3 x GN1/1 - 200(h) mm
	96 x 68 x 102(h) cm	130 x 68 x 102(h) cm
	2.670 €	3.200 €

CT 1766 CT 1771



CT1771







IT Carrelli termici a bagnomaria armadiati. Struttura in acciaio inox **AISI 304** - vano superiore in doppia parete coibentata - provvisti di rubinetto di scarico posto sul fondo - 2 ruote fisse e 2 multidirezionali ø 140 mm. Bacinelle escluse.

EN Bain-marie heated trolleys on counters. Structure in **AISI 304** stainless steel - insulated double-walled upper compartment - equipped with a drain valve on the bottom - 2 fixed wheels and 2 multidirectional wheels ø 140 mm. Containers not included.

FR Chariots chauffantes bain-marie sur meublé fermé. Structure en acier inox **AISI 304** - compartiment supérieur en double paroi isolée - 2 roues fixes et 2 roues multidirectionnelles ø 140 mm, équipées d'un robinet de vidange placé en bas. Bacs non compris.

DE Bain-Marie Heizwagen mit Schrankelement. Struktur aus Edelstahl **AISI 304** - oberes Fach mit isoliertem Doppelwand - ausgestattet mit einem unten angebrachten Ablaufventil - 2 feste Räder und 2 Mehrwegräder ø 140 mm. Behälter nicht enthalten.

A650 mod. CT 1766	A700 mod. CT 1771
Vano inferiore riscaldato - Heated lower compartment Compartiment inferieur chauffé - Beheiztes Unterfach	
270 €	

	CT 1766	CT 1771
	2000 W	
	220-240V/1N/50-60 Hz	
	+30° +90°C	
	2 x GN1/1 - 200(h) mm	3 x GN1/1 - 200(h) mm
	96 x 68 x 92(h) cm	130 x 68 x 92(h) cm
	2.120 €	2.630 €

CT 1765TD CT 1770TD



CT 1765TD



IT Carrelli termici a bagnomaria armadiati con temperatura differenziata. Struttura in acciaio inox **AISI 304** - vano superiore in doppia parete coibentata - coperchi apribili a compasso fino a 180° per formare un piano di appoggio - provvisti di rubinetto di scarico posto sul fondo - 2 ruote fisse e 2 multidirezionali ø 140 mm. Bacinelle escluse - le temperature di lavoro indicate sono da considerarsi con coperchi posizionati.

EN Bain-marie heated trolleys on counters with differentiated temperature. Structure in **AISI 304** stainless steel - insulated double-walled upper compartment - lids that can be opened up to 180° to form a support surface. Equipped with a drain valve on the bottom - 2 fixed wheels and 2 multidirectional wheels ø 140 mm. Containers not included - the operating temperatures listed are to be considered with lids on.

FR Chariots bain-marie chauffés à température différenciée. Structure en acier inox **AISI 304** - compartiment supérieur en double paroi isolée - couvercles pouvant s'ouvrir jusqu'à 180° pour former une surface d'appui - 2 roues fixes et 2 roues multidirectionnelles ø 140 mm, équipées d'un robinet de vidange placé en bas. Bacs non compris - les températures de travail indiquées sont à considérer avec couvercles en place.

DE Bain-Marie Heizwagen mit Schrankelement mit unterschiedlichen Temperaturen. Struktur aus Edelstahl **AISI 304** - oberes Fach in isolierter Doppelwand - Deckel bis zu 180° öffnungsfähig, um eine Auflagefläche zu bilden, ausgestattet mit einem unten angebrachten Ablaufventil - 2 feste Räder und 2 Mehrwegräder ø 140 mm. Behälter nicht enthalten - die angegebenen Arbeitstemperaturen sind bei aufgesetzten Deckeln zu verstehen.

A650 mod. CT 1765TD	A700 mod. CT 1770TD
Vano inferiore riscaldato - Heated lower compartment Compartiment inferieur chauffé - Beheiztes Unterfach	
270 €	

	CT 1765TD	CT 1770TD
	2000 W	3000 W
	220-240V/1N/50-60 Hz	
	+30° +90°C	
	2 x GN1/1 - 150(h) mm	3 x GN1/1 - 150(h) mm
	96 x 68 x 102(h) cm	130 x 68 x 102(h) cm
	2.850 €	3.435 €

CT 1766TD CT 1771TD



CT 1771TD







IT Carrelli termici a bagnomaria armadiati con temperatura differenziata. Struttura in acciaio inox **AISI 304** - vano superiore in doppia parete coibentata - provvisti di rubinetto di scarico posto sul fondo - 2 ruote fisse e 2 multidirezionali ø 140 mm. Bacinelle escluse.

EN Bain-marie heated trolleys on counters with differentiated temperature. Structure in **AISI 304** stainless steel - insulated double-walled upper compartment - Equipped with a drain valve on the bottom - 2 fixed wheels and 2 multidirectional wheels ø 140 mm. Containers not included.

FR Bain-marie heated trolleys on counters with differentiated temperature. Structure in **AISI 304** stainless steel - insulated double-walled upper compartment - équipée d'un robinet de vidange en bas - 2 roues fixes et 2 roues multidirectionnelles ø 140 mm. Bacs non compris.

DE Bain-Marie Heizwagen mit Schrankelement mit unterschiedlichen Temperaturen. Struktur aus Edelstahl **AISI 304** - oberes Fach in isolierter Doppelwand - ausgestattet mit einem unten angebrachten Ablaufventil - 2 feste Räder und 2 Mehrwegräder ø 140 mm. Behälter nicht enthalten.

A650 mod. CT1766TD	A700 mod. CT1771TD
Vano inferiore riscaldato - Heated lower compartment Compartment inferieur chauffé - Beheiztes Unterfach	
270 €	

	CT 1766TD	CT 1771TD
	2000 W	3000 W
 1 Ph	220-240V/1N/50-60 Hz	
	+30° +90°C	
	2 x GN1/1 - 150(h) mm	3 x GN1/1 - 150(h) mm
	96 x 68 x 92(h) cm	130 x 68 x 92(h) cm
	2.385 €	2.860 €

CT 1756 - CTS 1757
 CT 1758 - CTS 1759
 CT 1760 - CTS 1761
 CT 1762









CT 1760

IT Carrelli termici. Struttura in acciaio inox **AISI 304** - vasca a doppia parete - termostato regolabile - maniglia direzionale - ruote multidirezionali ø 125 mm. Bacinelle escluse - le temperature di lavoro indicate sono da considerarsi con coperchi posizionati.

EN Heated trolleys. Stainless steel **AISI 304** structure - double walled bowl - adjustable thermostat - directional handle - multidirectional wheels ø 125 mm. Containers not included - the operating temperatures listed are to be considered with lids on.

FR Chariots chauffants. Structure en acier inox **AISI 304** - cuve à double paroi - thermostat réglable - poignée directionnelle - roues multidirectionnelles ø 125 mm. Bacs non compris - les températures de travail indiquées sont à considérer avec couvercles en place.

DE Heizwagen. Struktur aus Edelstahl **AISI 304** - Doppelwandige Wanne - einstellbarer Thermostat - Lenkergriff - Mehrwegräder ø 125 mm. Behälter nicht enthalten - die angegebenen Arbeitstemperaturen sind bei aufgesetzten Deckeln zu verstehen.

	A BAGNOMARIA / BAIN MARIE				CON RESISTENZA A SECCO / WITH DRY HEATING ELEMENT		
	CT 1756	CT 1758	CT 1760	CT 1762	CTS 1757	CTS 1759	CTS 1761
	2000 W				1000 W	2000 W	
	220-240V/1N/50-60 Hz						
	+30° +90°C						
	1 x GN1/1 - 200(h) mm	2 x GN1/1 - 200(h) mm	3 x GN1/1 - 200(h) mm	4 x GN1/1 - 200(h) mm	1 x GN1/1 - 200(h) mm	2 x GN1/1 - 200(h) mm	3 x GN1/1 - 200(h) mm
	56 x 65 x 85(h) cm	84 x 65 x 85(h) cm	117 x 65 x 85(h) cm	148 x 65 x 85(h) cm	56 x 65 x 85(h) cm	84 x 65 x 85(h) cm	117 x 65 x 85(h) cm
	970 €	1.115 €	1.270 €	1.475 €	760 €	925 €	1.115 €





Elementi riscaldanti e vetrine neutre

HEATING ELEMENTS
AND NEUTRAL DISPLAYS
ÉLÉMENTS CHAUFFANTS
ET VITRINES NEUTRES
HEIZELEMENTE
UND NEUTRALE VITRINEN

BM 1780 - BM 1782 BM 1784 - BM 1786



BM 1784

BMS 1781 - BMS 1783 BMS 1785



BMS 1785

IT Tavole calde a bagnomaria. Struttura in acciaio inox **AISI 304** - parete coibentata - rubinetto di scarico - termostato regolabile. Le bacinelle sono escluse.

EN Bain-marie heated tables. Stainless steel **AISI 304** structure - insulated wall - drain valve - adjustable thermostat. Containers not included.

FR Tables chaudes avec bain-marie. Structure en acier inox **AISI 304** - paroi isolée - robinet de vidange - thermostat réglable. Les bacs ne sont pas compris.







DE Bain-Marie Heitzische. Struktur aus Edelstahl **AISI 304** - isolierte Wand - Ablaufventil - einstellbarer Thermostat. Behälter nicht enthalten.





IT Tavole calde con resistenza a secco (senza acqua). Struttura in acciaio inox **AISI 304** - parete coibentata - termostato regolabile. Le bacinelle sono escluse.

EN Heated tables with dry heating element (without water). Stainless steel **AISI 304** structure - insulated wall - adjustable thermostat. Containers not included.

FR Heated tables with dry heating element (without water). Stainless steel **AISI 304** structure - insulated wall - adjustable thermostat. Containers not included.

DE Heitzische mit Trockenheizstab (ohne Wasser). Struktur aus Edelstahl **AISI 304** - isolierte Wand - einstellbarer Thermostat. Behälter nicht enthalten.

	BM 1780	BM 1782	BM 1784	BM 1786
	2000 W			
 1 Ph	220-240V/1N/50-60 Hz			
	+30° +90°C			
	1 x GN1/1 200(h) mm	2 x GN1/1 200(h) mm	3 x GN1/1 200(h) mm	4 x GN1/1 200(h) mm
	49 x 60 x 32(h) cm	78 x 60 x 32(h) cm	110 x 60 x 32(h) cm	144 x 60 x 32(h) cm
	800 €	960 €	1.100 €	1.220 €

	BMS 1781	BMS 1783	BMS 1785
	1000 W		
 1 Ph	220-240V/1N/50-60 Hz		
	+30° +90°C		
	1 x GN1/1 - 200(h) mm	2 x GN1/1 - 200(h) mm	3 x GN1/1 - 200(h) mm
	49 x 60 x 32(h) cm	78 x 60 x 32(h) cm	110 x 60 x 32(h) cm
	550 €	735 €	910 €

Tavole calde
Heated tables

BM 11 - BM 21 BM 31



BM 11

BMV 11 - BMV 21 BMV 31



BMV 21

IT Tavole calde a bagnomaria. Struttura in acciaio inox - termostato regolabile. Le bacinelle sono escluse.

EN Bain-marie heated tables. Stainless steel structure - adjustable thermostat. Containers not included.

FR Tables chaudes avec bain-marie . Structure en acier inox - thermostat réglable. Les bacs ne sont pas compris.







DE Bain-Marie Heiztische. Edelstahlstruktur - einstellbarer Thermostat. Behälter nicht enthalten.

IT Tavole calde a bagnomaria. Struttura in acciaio inox - rubinetto di scarico - temperature vasche differenziate - termostato regolabile. Le bacinelle sono escluse.

EN Bain-marie heated tables. Stainless steel structure - drain valve - differentiated bowl temperatures - adjustable thermostat. Containers not included.

FR Tables chaudes avec bain-marie . Structure en acier inox - robinet de vidange - différentes températures des cuves - thermostat réglable. Les bacs ne sont pas compris.

DE Bain-Marie Heiztische. Edelstahlstruktur - Ablaufventil - unterschiedliche Temperaturen - einstellbarer Thermostat. Behälter nicht enthalten.

	BM 11	BM 21	BM 31
	1200 W	1200 + 1200 W	1000 + 1000 +1000 W
	220-240V/1N/50-60 Hz		
	+30° +90°C		
	1 x GN1/1 - 150(h) mm	2 x GN1/1 - 150(h) mm	3 x GN1/1 - 150(h) mm
	54 x 33 x 22(h) cm	66 x 54 x 22(h) cm	99 x 54 x 22(h) cm
	340 €	465 €	630 €

	BMV 11	BMV 21	BMV 31
	1200 W	1200 + 1200 W	1000 + 1000 +1000 W
	220-240V/1N/50-60 Hz		
	+30° +90°C		
	1 x GN1/1 - 150(h) mm	2 x GN1/1 - 150(h) mm	3 x GN1/1 - 150(h)mm
	54 x 33 x 22(h) cm	66 x 54 x 22(h) cm	99 x 54 x 22(h) cm
	385 €	560 €	775 €

BM 7700



BMP 7720



IT Tavola calda a bagnomaria. Struttura in acciaio inox - bacinella esclusa.

EN Bain-marie heated table. Stainless steel structure - containers not included.

FR Table chaude avec bain-marie . Structure en acier inox - bacs pas compris.

DE Bain-Marie Heiztisch. Edelstahlstruktur - Behälter nicht enthalten.

IT Tavola calda a bagnomaria. Struttura in acciaio inox - modello compreso di 2 pentole da 8 L.

EN Bain-marie heated table. Stainless steel structure - with 2 pans of 8 L.

FR Table chaude avec bain-marie . Structure en acier inox - modèle équipé de 2 marmites de 8 L.

DE Bain-Marie Heiztisch. Struktur aus Edelstahl - Modell mit 2 Kesseln 8 L je.

	BM 7700
	1200 W
	220-240V/1N/50-60 Hz
	+30° +90°C
	1 x GN1/1 - 150(h) mm
	57 x 37 x 22(h) cm
	185 €

	BMP 7720
	1200 W
	220-240V/1N/50-60 Hz
	+30° +90°C
	2 pentole 2 pots
	57 x 37 x 28(h) cm
	265 €

Tavole calde
Heated tables

PC 4750 - PC 4752
 PC 4754 - PC 5050
 PC 6040 - PC 8060



PC 4754

- IT Piani caldi in acciaio inox.
 Struttura in acciaio inox **AISI 304** - termostato regolabile
- EN Hot plates in stainless steel.
 Stainless steel **AISI 304** structure - adjustable thermostat.
- FR Hot plates in stainless steel.
 Stainless steel **AISI 304** structure - adjustable thermostat.
- DE Heiße Edelstahlplatten.
 Struktur aus Edelstahl **AISI 304** - einstellbarer Thermostat.

	PC 4750	PC 4752	PC 4754
	250 W	450 W	600 W
 1 Ph	220-240V/1N/50-60 Hz		
	+30° +90°C		
	50 x 35 x 6(h) cm	90 x 45 x 6(h) cm	100 x 50 x 6(h) cm
	200 €	260 €	300 €

	PC 5050	PC 6040	PC 8060
	600 W		1000 W
 1 Ph	220-240V/1N/50-60 Hz		
	+30° +90°C		
	50 x 50 x 6(h) cm	60 x 40 x 6(h) cm	80 x 60 x 6(h) cm
	260 €	260 €	355 €

PVC 4760
 PVC 4763
 PVC 4765



PVC 4760

- IT Piani caldi con piano in vetro temperato.
 Struttura in acciaio inox **AISI 304** - termostato regolabile.
- EN Hot plates with tempered glass top.
 Stainless steel **AISI 304** structure - adjustable thermostat.
- FR Plaques chauffantes avec plan en verre trempé.
 Structure en acier inox **AISI 304** - thermostat réglable.
- DE Heiße Platten mit gehärteter Glasoberfläche.
 Struktur aus Edelstahl **AISI 304** - einstellbarer Thermostat.

	PVC 4760	PVC 4763	PVC4765
	600 W		1000 W
 1 Ph	220-240V/1N/50-60 Hz		
	+30° +90°C		
	50 x 50 x 7(h) cm	60 x 40 x 7(h) cm	81 x 61 x 7(h) cm
	390 €	390 €	490 €

PCC 4710 - PCC 4730



PCC 4710



PCC 4730

- IT Piani caldi con cupola in plexiglass.
Struttura in acciaio inox **AISI 304** - termostato regolabile
- EN Hot plates with Plexiglas dome.
Stainless steel **AISI 304** structure - adjustable thermostat.
- FR Plaques chauffantes avec clochette en plexiglas.
Structure en acier inox **AISI 304** - thermostat réglable.
- DE Heiße Platten mit Plexiglashaube.
Struktur aus Edelstahl **AISI 304** - einstellbarer Thermostat

	PCC 4710	PCC 4730
	450 W	600 W
	220-240V/1N/50-60 Hz	
	+30° +90°C	
	90 x 45 x 20(h) cm	100 x 50 x 30(h) cm
	525 €	595 €

PCI 4711 - PCI 4712 PCI 4713



PCI 4713

- IT Lampade a infrarossi con piano caldo in acciaio inox. Struttura in acciaio inox - termostato regolabile - copertura in policarbonato fumè.
- EN Infrared lamps with stainless steel heated plate. Stainless steel structure - adjustable thermostat - smoky grey polycarbonate lid.
- FR Lampes infrarouges avec plaque chaude en acier inox. Structure en acier inox - thermostat réglable - couvercle en polycarbonate fumé.
- DE Infrarot-Lampen mit Edelstahlwärmplatte. Struktur aus Edelstahl **AISI 304** - einstellbarer Thermostat - dunkle Polycarbonatabdeckung.

	PCI 4711	PCI 4712	PCI 4713
	250 + 250 W	450 + 500 W	600 + 750 W
	220-240V/1N/50-60 Hz		
	+30° +90°C		
	1 lampada 1 lamp	2 lampade 2 lamps	3 lampade 3 lamps
	45 x 64 x 80(h) cm	85 x 64 x 80(h) cm	127 x 68 x 80(h) cm
	515 €	625 €	845 €

Piani caldi
Hot plates

Lampade a raggi infrarossi
Infrared lamps

PI 4714 - PI 4715 PI 4716



IT Telaio con lampade a infrarossi.

EN Frame with infrared lamps.

FR Corps avec lampes infrarouges.

DE Rahmen mit Infrarotlampen.

PIA 4714 - PIA 4715 PIA 4716









IT Telaio con lampade a infrarossi da appendere.

EN Frame with hanging infrared lamps.

FR Corps avec lampes infrarouges suspendues.

DE Rahmen mit hängenden Infrarotlampen.





	PI 4714	PI 4715	PI 4716
	250 W	500 W	750 W
 1 Ph	220-240V/1N/50-60 Hz		
	+30° +90°C		
	1 lampada 1 lamp	2 lampade 2 lamps	3 lampade 3 lamps
	45 x 55 x 70(h) cm	85 x 55 x 70(h) cm	127 x 55 x 70(h) cm
	330 €	430 €	550 €

	PIA 4714	PIA 4715	PIA 4716
	250 W	500 W	750 W
 1 Ph	220-240V/1N/50-60 Hz		
	+30° +90°C		
	1 lampada 1 lamp	2 lampade 2 lamps	3 lampade 3 lamps
	45 x 68 x 25(h) cm	85 x 68 x 25(h) cm	128 x 68 x 25(h) cm
	265 €	370 €	465 €

PCI 4717 - PCI 4718 PCI 4718D



- IT Lampade a infrarossi con piano caldo in acciaio inox, in diversi modelli. Struttura in acciaio inox e termostato regolabile.
- EN Infrared lamps with stainless steel hot plate, in different models. Stainless steel structure and adjustable thermostat.
- FR Lampes infrarouges avec plaque chauffante en acier inox, en différents modèles. Structure en acier inox et thermostat réglable.
- DE Infrarotlampen mit Heizplatte aus Edelstahl, in verschiedenen Ausführungen. Edelstahlstruktur und einstellbarer Thermostat.

	PCI 4717	PCI 4718	PCI 4718D
	250 + 250 + 250 W	250 + 250 W	250 + 250 + 250 W
 1 Ph	220-240V/1N/50-60 Hz		
	+30° +90°C		
	2 lampade 2 lamps	1 lampada 1 lamp	2 lampade 2 lamps
 cm	60 x 40 x 68(h) cm	58 x 33 x 68(h) cm	
	420 €	340 €	410 €

BI 4719 - BI 4719D







- IT Lampade a infrarossi con contenitore Gastronorm GN1/1. Struttura in acciaio inox.
- EN Infrared lamps with Gastronorm GN1/1 container. Stainless steel structure
- FR Lampes infrarouges avec récipient Gastronorm GN1/1. Structure en acier inox.
- DE Infrarotlampen mit Gastronorm-Behälter GN1/1. Edelstahlstruktur

OPTIONAL A516

Vasca riscaldata
Heated bowl
Cuve chauffée
Beheizte Wanne

110 €

	BI 4719	BI 4719D
	250 W	
 1 Ph	220-240V/1N/50-60 Hz	
	+30° +90°C	
	1 lampada 1 lamp	2 lampade 2 lamps
 cm	60 x 33 x 68(h) cm	
	320 €	390 €

Lampade a raggi infrarossi
Infrared lamps

HLF - HLC



HLFA



HLECB

- IT Lampade riscaldanti a infrarossi a sospensione - disponibili in diverse forme come da foto, nei colori nero, argento, oro e rame.
- EN Infrared hanging heating lamps - available in different shapes as shown in the picture, in black, silver, gold and copper.
- FR Lampes chauffantes à infrarouge à suspension - disponibles en différentes formes comme indiqué sur la photo, en noir, argent, or et cuivre.
- DE Infrarot-Heizlampen zum Aufhängen - erhältlich in verschiedenen Formen, wie auf dem Bild gezeigt, in Schwarz, Silber, Gold und Kupfer.

i	HLFN nero / black	HLFA argento / silver	HLEFD oro / gold	HLEFB rame / copper
⚡	250 W			
1 Ph	220-240V/1N/50-60 Hz			
🌡️	+30° +90°C			
↗️ cm	ø 270 mm			
	95 €	95 €	120 €	120 €

i	HLCN nero / black	HLCA argento / silver	HLECD oro / gold	HLECB rame / copper
⚡	250 W			
1 Ph	220-240V/1N/50-60 Hz			
🌡️	+30° +90°C			
↗️ cm	ø 270 mm			
	95 €	95 €	110 €	110 €

HLA - HLE



HLEBD



HLEN

- IT Lampade riscaldanti a infrarossi a sospensione - disponibili in diverse forme come da foto, nei colori nero, argento, oro e rame.
- EN Infrared hanging heating lamps - available in different shapes as shown in the picture, in black, silver, gold and copper.
- FR Lampes chauffantes à infrarouge à suspension - disponibles en différentes formes comme indiqué sur la photo, en noir, argent, or et cuivre.
- DE Infrarot-Heizlampen zum Aufhängen - erhältlich in verschiedenen Formen, wie auf dem Bild gezeigt, in Schwarz, Silber, Gold und Kupfer.

	HLAN nero / black	HLAA argento / silver	HLEBD oro / gold	HLEBB rame / copper
	250 W			
	220-240V/1N/50-60 Hz			
	+30° +90°C			
	ø 175 mm			
	90 €	90 €	100 €	100 €

	HLEN nero / black	HLEA argento / silver	HLEED oro / gold	HLEEB rame / copper
	250 W			
	220-240V/1N/50-60 Hz			
	+30° +90°C			
	ø 290 mm			
	95 €	95 €	110 €	110 €

Lampade a raggi infrarossi
Infrared lamps

VBR 4751 - VBR 4752 - VBR 4753 VBR 4781 - VBR 4782 - VBR 4783



VBR 4751



VBR 4752



VBR 4753

IT Vettrine riscaldate. Struttura in acciaio inox **AISI 304** - fianchi e antine sui due fronti in plexiglass trasparente - termostato regolabile - dispositivo di umidificazione.

EN Heated display cases. Structure in stainless steel **AISI 304** - Plexiglas sides and doors on both sides - adjustable thermostat - humidification device.

FR Vitrines chauffées. Structure en acier inox **AISI 304** - côtés et portes des deux côtés en plexiglas transparent - thermostat réglable - dispositif d'humidification.

DE Beheizte Vitrinen. Struktur aus Edelstahl **AISI 304** - Seiten und Türen auf beiden Seiten aus transparentem Plexiglas - einstellbarer Thermostat - Befeuchtungsvorrichtung.

OPTIONAL
PRI50 - 250 W
VBR4751 - VBR4752 - VBR4753 - VBR4756







Piano intermedio riscaldato
Heated intermediate shelf
Étagère intermédiaire chauffée
Beheiztes Zwischenfach

195 €

OPTIONAL
PRI85 - 400 W
VBR4781 - VBR4782 - VBR4783 - VBR4786

Piano intermedio riscaldato
Heated intermediate shelf
Étagère intermédiaire chauffée
Beheiztes Zwischenfach

270 €

	VBR 4751	VBR 4781	VBR 4752	VBR 4782	VBR 4753	VBR 4783
	250 W	400 W	250 W	400 W	400 W	
	220-240V/1N/50-60 Hz					
	+30° +90°C					
	1		2		3	
	50 x 35 x 25(h) cm	85 x 35 x 25(h) cm	50 x 35 x 40(h) cm	85 x 35 x 40(h) cm	50 x 35 x 54(h) cm	85 x 35 x 54(h) cm
	385 €	470 €	515 €	630 €	615 €	780 €

VBR 4756 - VBR 4786





VBR 4786

IT Vetrine riscaldate. Struttura in acciaio inox **AISI 304** - fianchi e antine sui due fronti in plexiglass trasparente - termostato regolabile - dispositivo di umidificazione.

EN Heated display cases. Structure in stainless steel **AISI 304** - Plexiglas sides and doors on both sides - adjustable thermostat - humidification device.

FR Vitrines chauffées. Structure en acier inox **AISI 304** - côtés et portes des deux côtés en plexiglas transparent - thermostat réglable - dispositif d'humidification.

DE Beheizte Vitrinen. Struktur aus Edelstahl **AISI 304** - Seiten und Türen auf beiden Seiten aus transparentem Plexiglas - einstellbarer Thermostat - Befeuchtungsvorrichtung.

	VBR 4756	VBR 4786
	250 W	400 W
	220-240V/1N/50-60 Hz	
	+30° +90°C	
	2	
	50 x 35 x 40(h) cm	85 x 35 x 40(h) cm
	500 €	640 €

Vetrine riscaldanti
Heated display cases

VBN 4756 - VBN 4786



VBN 4756

IT Vetrine neutre. Struttura in acciaio inox **AISI 304** - fianchi e antine sui due fronti in plexiglass trasparente.

EN Neutral display cases. Structure in stainless steel **AISI 304** - clear Plexiglas sides and doors on both sides .

FR Vitrines neutres. Structure en acier inox **AISI 304** - côtés et portes des deux côtés en plexiglas transparent.

DE Neutrale Vitrinen. Struktur aus Edelstahl **AISI 304** - Seiten und Türen auf beiden Seiten aus transparentem Plexiglas.

	VBN 4756	VBN 4786
	2	
	50 x 35 x 40(h) cm	85 x 35 x 40(h) cm
	325 €	445 €

Vetrine neutre
Neutral display cases

VBN 4751 - VBN 4781
 VBN 4752 - VBN 4782
 VBN 4753 - VBN 4783



VBN 4751

IT Vetrine neutre. Struttura in acciaio inox **AISI 304** - fianchi e antine sui due fronti in plexiglas trasparente .

EN Neutral display cases. Structure in stainless steel **AISI 304** - clear Plexiglas sides and doors on both sides.

FR Vitrines neutres. Structure en acier inox **AISI 304** - côtés et portes des deux côtés en plexiglas transparent.

DE Neutrale Vitrinen. Struktur aus Edelstahl **AISI 304** - Seiten und Türen auf beiden Seiten aus transparentem Plexiglas.

VBE 50



VBE 85





IT Vetrina porta brioches e croissant. Struttura unica completamente in plexiglas con antine apribili sui due lati.

EN Brioche and croissants display case. Single structure completely in Plexiglas with openable doors on both sides.

FR Vitrine pour brioches et croissants. Structure unique entièrement en plexiglas avec portes qui peuvent être ouvertes des deux côtés.

DE Vitrine für Croissants und Hörnchen. Struktur komplett aus Plexiglas mit zweiseitig aufklappbaren Türen.

	VBE 50	VBE 85
 N.	1	
 cm	50 x 35 x 18(h) cm	85 x 35 x 18(h) cm
	180 €	240 €

	VBN 4751	VBN 4781	VBN 4752	VBN 4782	VBN 4753	VBN 4783
 N.	1		2		3	
 cm	50 x 35 x 25(h) cm	85 x 35 x 25(h) cm	50 x 35 x 36(h) cm	85 x 35 x 36(h) cm	50 x 35 x 50(h) cm	85 x 35 x 50(h) cm
	205 €	285 €	320 €	440 €	420 €	575 €

VL 4748 - VL 4749



VL 4748



VL 4748 CA



VL 4748 B



VL 4749



VL 4749 CA



VL 4749 B

IT Vetrina porta brioches e croissant. Piano in legno. Cupola in plexiglass semitrasparente con antine apribili sui 2 lati.

EN Brioches and croissants display case. Wooden top. Semi-transparent Plexiglas dome with openable doors on 2 sides.

FR Vitrine pour brioches et croissants. Plan en bois. Clochette en plexiglas semi-transparente avec portes qui peuvent être ouvertes des deux côtés.

DE Vitrine für Croissants und Hörnchen. Halbtransparente Plexiglashaube zweiseitig aufklappbare Türen.

	VL 4748 noce/walnut	VL 4748CA carbon	VL 4748B laccato bianco laquered white	VL 4749 noce/walnut	VL 4749CA carbon	VL 4749B laccato bianco laquered white
	1					
	50 x 35 x 21(h) cm			85 x 35 x 21(h) cm		
	225 €		235 €	275 €		290 €

Vitrine neutre
Neutral display cases

VPH 100 - VPH 120 VPH 160



VPH 100

- IT Vetrine riscaldate con griglie - doppio vetro - struttura in acciaio inox **AISI 304** - termostato regolabile.
- EN Heated display cases, with grids - double-glazed - structure in stainless steel **AISI 304** - adjustable thermostat.
- FR Vitrines chauffées, avec grilles - double vitrage - structure en acier inox **AISI 304** - thermostat réglable.
- DE Beheizte Vitrinen, mit Gitter - Doppelglas - Struktur aus Edelstahl **AISI 304** - einstellbarer Thermostat.

i	VPH 100	VPH 120	VPH 160
⚡	1100 W		
🔌 1 Ph	220-240V/1N/50-60 Hz		
🌡️	+30° +90°C		
N.	2 piani - 2 griglie 2 shelves - 2 grids		
↗️ cm	71 x 46 x 67(h) cm GRC100A 643x272 mm GRC100B 643x303 mm	71 x 58 x 67(h) cm GRC120A 643x374 mm GRC120B 643x402 mm	88 x 58 x 67(h) cm GRC160A 819x374 mm GRC160B 819x407 mm
	675 €	885 €	1.055 €

MS 1860RF2 MS 1862RF2 MS 1866RF2



MS 1862RF2

- IT Mobiletto scaldapiatti. Struttura in acciaio inox **AISI 304** coibentata - termostato regolabile - 1 ripiano intermedio - ruote multidirezionali ø 95 mm di cui 2 con freno.
- EN Plate warmer cabinet. **AISI 304** stainless steel structure insulated - adjustable thermostat - 1 intermediate shelf - multidirectional wheels ø 95 mm - 2 wheels with brake.
- FR Armoire chauffe-plat. Structure en acier inox **AISI 304** isolée - thermostat réglable - 1 étagère intermédiaire - roues multidirectionnelles de ø 95 mm - 2 roues avec frein.
- DE Tellerwärmer Schrank. Struktur aus Edelstahl **AISI 304** isolierte - einstellbarer Thermostat - 1 Zwischenablage - Mehrwegräder ø 95 mm - 2 mit Bremse.

i	MS 1860RF2	MS 1862RF2	MS 1866RF2
⚡	800 W		
🔌 1 Ph	220-240V/1N/50-60 Hz		
🌡️	+30° +90°C		
🍽️	60 piatti / plates 1 porta / doors	100 piatti / plates 2 porte / doors	120 piatti / plates 2 porte / doors
📏 mm	33 x 34,7 x 66,5(h) cm	64 x 34,7 x 53(h) cm	64 x 34,7 x 66,5(h) cm
↗️ cm	39 x 42 x 95(h) cm	70 x 42 x 80(h) cm	70 x 42 x 95(h) cm
	1.195 €	1.320 €	1.460 €

RTR 97L



RTR 97L2



RTR 137L



IT Vetrine riscaldate, da banco con griglie - doppio vetro - struttura in acciaio inox **AISI 304** - fianchi e antine sui due fronti in plexiglass trasparente - termostato regolabile.

EN Heated display cases, counter-top versions with grids - double-glazed - structure in stainless steel **AISI 304** - clear Plexiglas sides and doors on both sides - adjustable thermostat.

FR Vitrines chauffées, de table avec grilles - double vitrage - structure en acier inox **AISI 304** - côtés et portes des deux faces en plexiglas transparent - thermostat réglable.

DE Beheizte Vitrinen, Tischmodell mit Gitter - Doppelglas - Struktur aus Edelstahl **AISI 304** - Seiten und Türen auf beiden Seiten aus transparentem Plexiglas - einstellbarer Thermostat.

	RTR 97L	RTR 97L2	RTR 137L
	400 W		
	220-240V/1N/50-60 Hz		
	+30° +90°C		
	3 piani / shelves	4 piani tondi rotanti (ø 35 cm) 4 rotating round shelves (ø 35 cm)	3 piani / shelves
	46 x 45 x 78,5(h) cm		64,5 x 45 x 78,5(h) cm
	810 €	895 €	905 €

Vetrine riscaldanti con griglie
Heated display cases with grids



Carrelli per la cucina

KITCHEN TROLLEYS
CHARIOTS POUR LA CUISINE
KÜCHENWAGEN

CA 1450



CA 1460



CA 1470



IT Carrelli portavassoi. Struttura e guide in acciaio inox - paracolpi in gomma - ruote multidirezionali \varnothing 125 mm. Predisposti di serie per vassoi GN1/1 - 53x32,5 cm. Realizzabili su richiesta per qualsiasi misura di vassoio, da specificare al momento dell'ordine. Vassoi esclusi.

EN Tray trolleys - Stainless steel structure and slides - rubber shock absorbers - multidirectional wheels \varnothing 125 mm. Standard equipped for GN1/1 trays - 53x32,5 cm. Available on request for any tray size, to be mentioned when ordering. Trays not included.

FR Chariots porte plateaux. Structure et guides en acier inox - butoirs en caoutchouc - roues multidirectionnelles \varnothing 125 mm. Prêt en standard pour plateaux GN1/1 - 53x32,5 cm. Disponible sur demande pour toute taille de plateau, à préciser à la commande. Plaques pas compris.

DE Tablettwagen - GN1/1. Struktur und Führungen aus Edelstahl - Gummistoßschutz - Mehrwegräder \varnothing 125 mm. Standardmäßig vorgesehen für Bleche GN1/1 - 53x32,5 cm. Erhältlich auf Anfrage für jede Blechgröße, bitte bei der Bestellung angeben. Bleche nicht enthalten.

	CA 1450	CA 1460	CA 1470
 cm	45 x 62 x 175(h) cm	81 x 62 x 175(h) cm	117 x 62 x 175(h) cm
 N.	10 vassoi / trays	20 vassoi / trays	30 vassoi / trays
	370 €	560 €	745 €

Carrelli portavassoi GN1/1
GN1/1 tray trolleys

OPTIONAL



CA 1450P

CA 1460P

CA 1470P



h 12 cm



h 12 cm



h 12 cm

PANNELLI
LATERALI
SIDE
PANELS

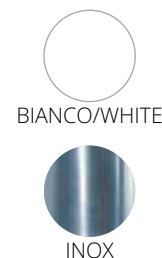

IT Carrelli portavassoi con pannelli laterali in perfix bianco, acciaio inox. Struttura e guide in acciaio inox - paracolpi in gomma - ruote multidirezionali \varnothing 125 mm. Predisposti di serie per vassoi GN1/1 - 53x32,5 cm. Realizzabili su richiesta per qualsiasi misura di vassoio e/o con pannello posteriore, da specificare al momento dell'ordine. Vassoi esclusi.

FR Chariots porte plateaux à panneaux latéraux en perfix blanc, acier inox. Structure et guides en acier inox - butoirs en caoutchouc - roues multidirectionnelles \varnothing 125 mm. Prêt en standard pour plateaux GN1/1 - 53x32,5 cm. Disponible sur demande pour toute taille de plateau et / ou avec panneau arrière, à préciser à la commande. Plaques pas compris.

EN Tray trolleys with side panels in white perfix, stainless steel. Stainless steel structure and slides - rubber shock absorbers - multidirectional wheels \varnothing 125 mm. Standard equipped for GN1/1 trays - 53x32,5 cm. Available on request for any tray size and/or with rear panel, to be mentioned when ordering. Trays not included.

DE Tablettwagen mit Seitenwänden in Weiß Perfix, Edelstahl oder. Struktur und Führungen aus Edelstahl - Gummistoßschutz - Mehrwegräder \varnothing 125 mm. Standardmäßig vorgesehen für Bleche GN1/1 - 53x32,5 cm. Erhältlich auf Anfrage für jede Blechgröße und / oder mit Rückwand, bitte bei der Bestellung angeben. Bleche nicht enthalten.

	CA1450P bianco-white	CA1450PI inox	CA1460P bianco-white	CA1460PI inox	CA1470P bianco-white	CA1470PI inox
	45 x 62 x 175(h) cm		81 x 62 x 175(h) cm		117 x 62 x 175(h) cm	
	10 vassoi / trays		20 vassoi / trays		30 vassoi / trays	
	425 €	475 €	610 €	665 €	795 €	835 €



Carrelli portavassoi con pannelli laterali GN1/1
GN1/1 Tray trolleys with side panels

CA 1451R

CA 1461R

CA 1471R



PANNELLI
LATERALI
SIDE
PANELS

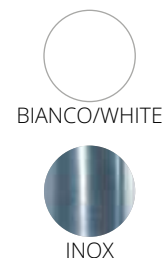

IT Carrelli portavassoi rinforzati, disponibili anche con pannelli laterali in perfix bianco o in acciaio inox. Struttura tubolare in acciaio inox 25x25 cm - guide in acciaio inox di spessore 1,2 mm - paracolpi in gomma - ruote multidirezionali \varnothing 125 mm. Predisposti di serie per vassoi GN1/1 - 53x32,5 cm. Realizzabili su richiesta per qualsiasi misura di vassoio e/o con pannello posteriore, da specificare al momento dell'ordine. Vassoi esclusi.

EN Reinforced tray trolleys also available with side panels in white perfix or stainless steel. Stainless steel tubular structure 25x25 mm - stainless steel slides with 1,2 mm thickness - rubber shock absorbers - multidirectional wheels \varnothing 125 mm. Standard equipped for GN1/1 trays - 53x32,5 cm. Available on request for any tray size and/or with rear panel, to be mentioned when ordering. Trays not included.

FR Chariots à plateaux renforcés disponibles aussi avec panneaux latéraux en perfix blanc ou acier inox. Structure tubulaire en acier inox 25x25 cm - guides en acier inox épaisseur 1,2 mm - butoir en caoutchouc - roues multidirectionnelles \varnothing 125 mm. Prêt en standard pour plateaux GN1/1 - 53x32,5 cm. Disponible sur demande pour toute taille de plateau et / ou avec panneau arrière, à préciser à la commande. Plaques pas compris.

DE Verstärkte Tablettwagen auch mit Seitenwänden aus weißem Perfix oder Edelstahl erhältlich. Struktur aus Edelstahl 25x25 mm - 1,2 mm dicke Edelstahlführungen - Gummistoßschutz - Mehrwegräder \varnothing 125 mm. Standardmäßig vorgesehen für Bleche GN1/1 - 53x32,5 cm. Erhältlich auf Anfrage für jede Blechgröße und / oder mit Rückwand, bitte bei der Bestellung angeben. Bleche nicht enthalten.

	CA1451R	CA1451RP bianco-white	CA1451RPI inox	CA1461R	CA1461RP bianco-white	CA1461RPI inox	CA1471R	CA1471RP bianco-white	CA1471RPI inox
	45 x 62 x 174(h) cm			81 x 62 x 174(h) cm			118 x 62 x 174(h) cm		
	10 vassoi / trays			20 vassoi / trays			30 vassoi / 30 trays		
	430 €	485 €	595 €	660 €	710 €	820 €	850 €	915 €	1.025 €

Carrelli portavassoi rinforzati GN1/1
GN1/1 tray trolleys - reinforced

OPTIONAL



CA 1455

CA 1465

CA 1475



h 12,5 cm



h 12,5 cm



h 12,5 cm

PANNELLI
LATERALI
SIDE
PANELS



BIANCO/WHITE



INOX

IT Carrelli portavassoi universali con possibilità di avere pannelli laterali in perfix bianco o in acciaio inox. Struttura in acciaio inox - guide in filo di acciaio cromato - paracolpi in gomma - ruote multidirezionali ø 125 mm. Vassoi esclusi.

FR Chariots à plateaux universels isponibles aussi avec panneaux latéraux en perfix blanc ou acier inox. Structure en acier inox - glissières en fil d'acier chromé - butoirs en caoutchouc - roues multidirectionnelles ø 125 mm. Plaques pas compris.

EN Universal tray trolleys also available with side panels in white perfix or stainless steel. Stainless steel structure - chromed steel wire slides - rubber shock absorbers - multidirectional wheels ø 125 mm. Trays not included.

DE Universal-Tablett Wagen auch mit Seitenwänden aus weißem Perfix oder Edelstahl erhältlich. Struktur aus Edelstahl - verchromte Stahldrahtführungen - Gummistoßschutz - Mehrwegräder ø 125 mm. Bleche nicht enthalten.

	CA 1455	CA 1455P bianco-white	CA 1455PI inox	CA1465	CA1465P bianco-white	CA1465PI inox	CA1475	CA1475P bianco-white	CA1475PI inox
	55 x 62 x 175(h) cm			95 x 62 x 175(h) cm			138 x 62 x 175(h) cm		
	10 vassoi / trays			20 vassoi / trays			30 vassoi / trays		
	375 €	460 €	505 €	585 €	665 €	705 €	800 €	875 €	920 €

CA 1455V12

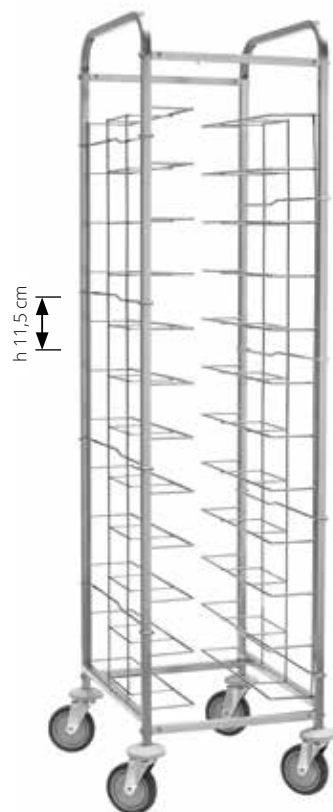

PT 15

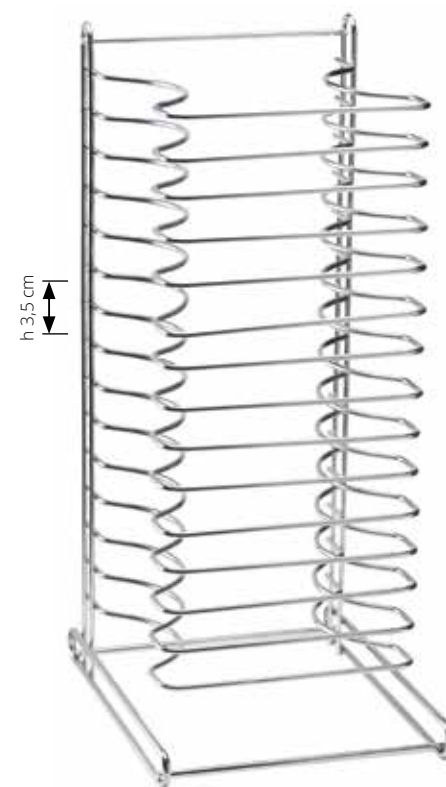

IT Carrello portavassoi universali con possibilità di avere pannelli laterali in perfex bianco o in acciaio inox. Struttura in acciaio inox - guide in filo di acciaio cromato - paracolpi in gomma - ruote multidirezionali \varnothing 125 mm.

EN Universal tray trolley. Stainless steel structure - chromed steel wire slides - rubber shock absorbers - multidirectional wheels \varnothing 125 mm.

FR Chariot à plateaux universels. Structure en acier inox - glissières en fil d'acier chromé - butoirs en caoutchouc - roues multidirectionnelles \varnothing 125 mm.

DE Universal-Tablett Wagen. Struktur aus Edelstahl - verchromte Stahldrahtführungen - Gummistoßschutz - Mehrwegräder \varnothing 125 mm.

IT Portateglie da banco per teglie tonde da cm. 26 a 32. Confezione minima 4 pz.

EN Table-top tray holder for round trays size 26 to 32 cm. Minimum pack 4 pcs.

FR Porte-plateau de table pour plateaux ronds de 26 à 32 cm. Paquet minimum de 4 pièces.

DE Tisch-Tabletthalterung für runde Tablette von 26 bis 32 cm. Mindestmenge 4 Stück.

	CA 1455V12
	52 x 62 x 185(h) cm
	12 vassoi / trays
	425 €

	PT 15
	38 x 29 x 67(h) cm
	15 teglie / trays
	90 €

Carrello portavassoi universali
Universal tray trolleys

Portateglie da banco
Table-top tray holder

CA 1476

CA 1477

CA 1478

CA 1479



IT Carrelli portateglie GN. Struttura e guide in acciaio inox - paracolpi in gomma - ruote multidirezionali \varnothing 125 mm. Predisposti di serie per GN2/1 e GN1/1. A richiesta possibilità di altre misure. Teglie escluse.

FR Chariots à plateaux GN. Structure et glissières en acier inox - butoirs en caoutchouc - roues multidirectionnelles \varnothing 125 mm. En standard pour GN2/1 et GN1/1. Autres mesures disponibles sur demande. Plateaux pas compris.

EN GN pans trolleys Stainless steel structure and slides - rubber shock absorbers - multidirectional wheels \varnothing 125 mm. Standard equipped for GN2/1 and GN1/1. Trays not included.

DE GN-Blechwagen. Struktur und Führungen aus Edelstahl - Gummistoßschutz - Mehrwegräder \varnothing 125 mm. Serienmäßig ausgerüstet für GN2/1 und GN1/1. Andere Größen sind auf Anfrage erhältlich. Bleche nicht enthalten.

	CA 1476	CA 1477	CA 1478	CA 1479
	64,5 x 72 x 182(h) cm	64,5 x 62 x 94(h) cm	44,5 x 62 x 94(h) cm	44,5 x 62 x 175(h) cm
	14 x GN2/1 - 28 x GN1/1	8 x GN2/1 - 16 x GN1/1	8 x GN1/1	14 x GN1/1
	405 €	440 €	420 €	385 €

CA 1489R

CA 1486R

CA 1492R





AV4947 60 x 30 x 2(h) cm	AV4937 60 x 40 x 2(h) cm
Teglia Blurex - Blurex tray Plaque Blurex - Blurex Form	
	
18 €	
AV4950 60 x 30 x 2(h) cm	AV4940 60 x 40 x 2(h) cm
Teglia alluminata - Aluminized pan Pan aluminisé - Aluminisierte pan	
	
23 €	
AV4980 60 x 40 x 2(h) cm	
Teglia in alluminio - Aluminium tray Plateau en aluminium Aluminiumschale	
	
30 €	

IT Carrelli portateglie GN rinforzati e Euronorm rinforzati. Struttura tubolare in acciaio inox 25x25 cm - guide in acciaio inox di spessore 1,2 mm - paracolpi in gomma - ruote multidirezionali ø 125 mm. Teglie escluse.

FR Chariots à plateaux GN/Euronorm renforcés. Structure tubulaire en acier inox 25x25 cm - glissières en acier inox épaisseur 1,2 mm - butoir en caoutchouc - roues multidirectionnelles ø 125 mm. Plateaux pas compris.

EN Euronorm and GN pans trolleys - reinforced. - reinforced Stainless steel tubular structure 25x25 mm - stainless steel slides with 1,2 mm thickness - rubber shock absorbers - multidirectional wheels ø 125 mm. Trays not included.

DE Verstärkte GN/Euronorm - Blechwagen. Edelstahlrohrstruktur 25x25 mm - 1,2 mm dicke Edelstahlführungen - Gummistoßschutz - Mehrwegräder ø 125 mm. Bleche nicht enthalten.

	CA 1489R	CA 1486R	CA 1492R
			
	45,5 x 62 x 177(h) cm	65,5 x 72 x 181(h) cm	53 x 72 x 181(h) cm
	14 x GN1/1	14 x GN2/1 - 28 x GN1/1	teglie / trays 14 x 60 x 40 cm
	595 €	545 €	600 €

Carrelli portateglie rinforzati GN1/1 - GN2/1 - 60x40 cm
GN1/1 - GN2/1 - 60x40 cm pans trolleys - reinforced

OPTIONAL



CA 1650 - CA 1655 CA 1656



CA 1656

CA 1650

CA 1482 - CA 1482 T20 CA 1483 - CA 1493



CA 1482

CA 1483

IT Carrelli portateglie 60x40 cm e porta bacinelle GN1/1 65(h) mm. Struttura in acciaio inox - guide in filo di acciaio cromato - paracolpi in gomma - ruote multidirezionali Ø 125 mm. Bacinelle e teglie escluse.

EN Tray trolleys 60x40 cm and trays GN1/165(h) mm. Stainless steel structure - chromed steel wire slides - rubber shock absorbers - multidirectional wheels Ø 125 mm. Containers and pans not included.

FR Chariots à plateaux 60x40 cm et pour bacs GN1/1 65(h) mm. Structure en acier inox - glissières en fil d'acier chromé - butoirs en caoutchouc - roues multidirectionnelles Ø 125 mm. Bacs et plaques pas compris.

DE Tablett Wagen 60x40 cm und Tablett GN1/1 65(h) mm. Struktur aus Edelstahl - verchromte Stahldrahtführungen - Gummistoßschutz - Mehrwegräder Ø 125 mm. Behältern und Bleche nicht enthalten.

IT Carrelli portateglie per pasticceria. Struttura e guide in acciaio inox - paracolpi in gomma - ruote multidirezionali Ø 125 mm. A richiesta altre misure disponibili. Teglie escluse.

EN Pastry tray trolleys Stainless steel structure and slides - rubber shock absorbers - multidirectional wheels Ø 125 mm. Other sizes available on request. Trays not included.

FR Chariots à plateaux pâtisserie. Structure et glissières en acier inox - butoirs en caoutchouc - roues multidirectionnelles Ø 125 mm. Autres mesures disponibles sur demande. Plateaux pas compris.

DE Konditorei-Blechwagen. Struktur und Führungen aus Edelstahl - Gummistoßschutz - Mehrwegräder Ø 125 mm. Andere Größen sind auf Anfrage erhältlich. Bleche nicht enthalten.

	CA 1655	CA 1656	CA 1650
	67 x 46 x 117(h) cm	67 x 46 x 153(h) cm	51,5 x 67 x 175(h) cm
	GN1/1 65(h) mm 10 teglie / trays 60x40 cm	GN1/1 65(h) mm 15 teglie / trays 60x40 cm	GN1/1 65(h) mm 10 teglie / trays 60x40 cm e vassoi / trays
	390 €	470 €	415 €

	CA 1482	CA 1482 T20	CA 1483	CA 1493
	52 x 72 x 182(h) cm		52 x 72 x 94(h) cm	72 x 87 x 94(h) cm
	14 teglie / trays 60 x 40 cm	20 teglie / trays 60 x 40 cm	8 teglie / trays 60 x 40 cm	8 teglie / trays 80 x 60 cm 16 teglie / trays 60 x 40 cm
	460 €	570 €	475 €	590 €

CA 1480

CA 1480D

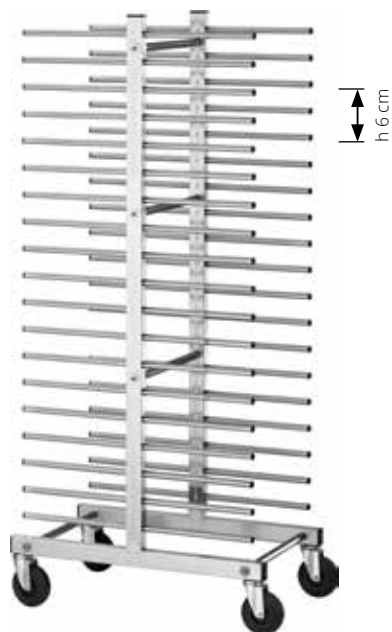

IT Carrelli portateglie universali. Struttura e guide in acciaio inox - paracolpi in gomma - ruote multidirezionali \varnothing 125 mm. Teglie escluse

EN Universal tray trolleys. Stainless steel structure and slides - rubber shock absorbers - multidirectional wheels \varnothing 125 mm. Trays not included.

FR Chariots à plateaux universels. Structure et glissières en acier inox - butoirs en caoutchouc - roues multidirectionnelles \varnothing 125 mm. Plateaux pas compris.

DE Universal-Blechwagen. Struktur und Führungen aus Edelstahl - Gummistoßschutz - Mehrwegräder \varnothing 125 mm. Bleche nicht enthalten.

	CA 1480	CA 1480D
	50 x 51 x 177(h) cm	50 x 81 x 177(h) cm
	20 teglie / trays	40 teglie / trays
	450 €	535 €

Optional

A500

Bacinella portabottiglie in acciaio inox
Stainless steel bottle tray
Porte-bouteilles en acier inox
Edelstahl Flaschenhalter

120 €



A 512

Ruote con freno - Wheels with catch
Roues avec frein - Räder mit Bremse

CA1450 - CA1455 - CA1460 - CA1470 - CA1465 - CA1475 - CA1477
CA1476 - CA1478 - CA1479 - CA1480 - CA1480D - CA1482
CA1482T20 - CA1483 - CA1493 - CA1650 - CA1655 - CA1656

10 € cad./each

A 514

Ruote con freno - Wheels with catch
Roues avec frein - Räder mit Bremse

CA1451 - CA1461 - CA1471 - CA1489R - CA1486R - CA1492

16 € cad./each



A 512



A 514

Carrelli portateglie per pasticceria rinforzati
Reinforced pastry tray trolleys



Carrelli portapiatti e cestelli

PLATE AND BASKETS TROLLEYS
PORTE-ASSIETTES ET PANIERS
TELLER- UND KORBWAGEN

CA 1435
CA 1436
CA 1435G
CA 1436G



GRIGLIA
VERNICIATA
PAINTED
GRID



GRIGLIA
CROMATA
CHROME
PLATED GRID



WARNING

Dimensioni imballo
Packing dimensions
35 x 90 x 50(h) cm



CA 1435

CA 1437
CA 1438
CA 1437G
CA 1438G



GRIGLIA
VERNICIATA
PAINTED
GRID



GRIGLIA
CROMATA
CHROME
PLATED GRID



WARNING

Dimensioni imballo
Packing dimensions
35 x 165 x 50(h) cm

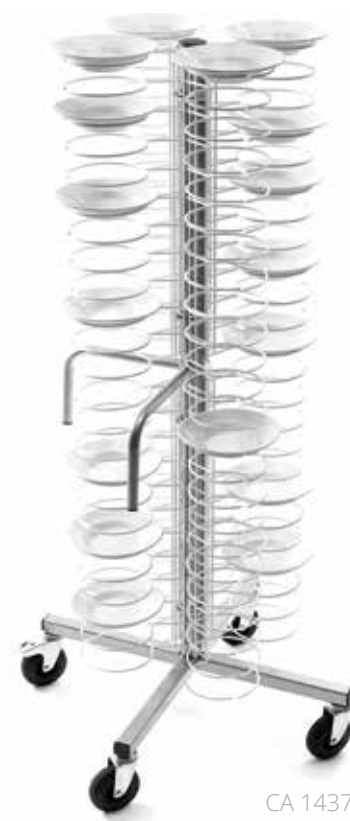

CA 1437

IT Colonna portapiatti da banco. Struttura in acciaio plastificato - griglie verniciate o cromate - piedini regolabili.

EN Countertop tiered plate holder stand. Plastic-coated steel structure - painted or chromed grids - adjustable feet.

FR Colonne porte-assiettes de table. Structure en acier plastifié - grilles peintes ou chromées - pieds réglables.



DE Tellerwagen, Tischmodell. Struktur aus kunststoffbeschichtetem Stahl - lackierte oder verchromte Gitter - verstellbare FüÙe.



IT Carrelli portapiatti. Struttura in acciaio plastificato - griglie verniciate o cromate - maniglie per conduzione carrello - ruote ø 125 mm di cui due con freno.

EN Plate trolleys. Plastic-coated steel structure - painted or chrome-plated grids - handles for trolley operation - ø 125 mm wheels, two of which with brakes.

FR Chariots à assiettes. Structure en acier plastifié - grilles peintes ou chromées - poignées pour l'entraînement du chariot - roues de ø 125 mm, dont deux avec freins.

DE Tellerwagen. Struktur aus kunststoffbeschichtetem Stahl - lackierte oder verchromte Gitter - Lenkergriff - Räder ø 125 mm, davon zwei mit Bremsen.

	CA 1435 griglie verniciate painted grid	CA 1436 griglie cromate chrome-plated grill	CA 1435G griglie verniciate painted grid	CA 1436G griglie cromate chrome-plated grill
	60 x 60 x 83(h) cm		70 x 70 x 83(h) cm	
	48 piatti / plates ø 18/23 cm		48 piatti / plates ø 25/31 cm	
	380 €	400 €	390 €	450 €

	CA 1437 griglie verniciate painted grid	CA 1438 griglie cromate chrome-plated grill	CA 1437G griglie verniciate painted grid	CA 1438G griglie cromate chrome-plated grill
	60 x 60 x 173(h) cm		70 x 70 x 173(h) cm	
	96 piatti / plates ø 18/23 cm		96 piatti / plates ø 25/31 cm	
	660 €	685 €	700 €	735 €

Portapiatti da banco
Table top plate rack



Confezionamento in kit per risparmio costi trasporto
Packing in set for saving transport charges
Emballage en kit pour sauver frais d'expédition
Verpackung in kit um Versandkosten zu sparen

CA 1439P



WARNING

Dimensioni imballo
Packing dimensions
40 x 165 x 68(h) cm
peso / weight 50 kg

Confezionamento in kit per
risparmio costi trasporto
Packing in set for saving
transport charges
Emballage en kit pour sauver
frais d'expédition
Verpackung in kit um
Versandkosten zu sparen



IT Portapiatti da parete. Struttura in acciaio plastificato - griglie plastificate.

EN Wall plate holder. Plastic-coated steel structure - plastic-coated grids.

FR Porte-assiettes à mur. Structure en acier plastifié - grilles plastifiées.

DE Wandtellerhalter. Kunststoffbeschichtete Stahlstruktur - beschichtete Gitter.

	CA 1439P
	42 x 20 x 90(h) cm
	12 piatti / plates ø 18/23 cm
	110 €

CA 1439 CA 1440 CA 1439G CA 1440G



GRIGLIA
VERNICIATA
PAINTED
GRID



WARNING



GRIGLIA
CROMATA
CHROME
PLATED GRID

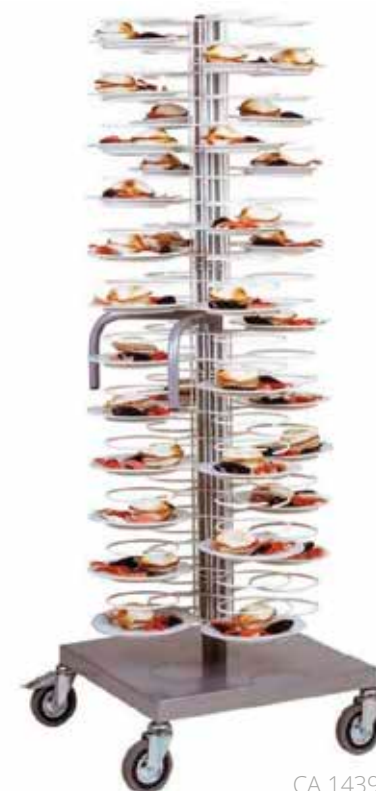

CA 1439

IT Carrelli portapiatti. Struttura in acciaio plastificato con base in lamiera antipolvere - griglie verniciate o cromate - maniglie per conduzione carrello - ruote ø 125 mm di cui due con freno.

EN Plate trolleys. Plastic-coated steel structure with dust-proof lower shelf - painted or chrome-plated grids - handles for trolley operation - ø 125 mm wheels, two of which with brakes.

FR Chariots à assiettes. Structure en acier plastifié avec base en tôle anti-poussière - grilles peintes ou chromées - poignées pour l'entraînement du chariot - roues de ø 125 mm, dont deux avec freins.

DE Tellerwagen. Struktur aus kunststoffbeschichtetem Stahl mit staubdichtem Boden - lackierte oder verchromte Gitter - Lenkergriff - Räder ø 125 mm, davon zwei mit Bremsen.

	CA 1439 griglie verniciate painted grid	CA 1440 griglie cromate chrome-plated grill	CA1439G griglie verniciate painted grid	CA1440G griglie cromate chrome-plated grill
	60 x 60 x 175(h) cm		70 x 70 x 175(h) cm	
	96 piatti / plates ø 18/23 cm		96 piatti / plates ø 25/31 cm	
	780 €	810 €	820 €	895 €

Carrelli portapiatti
Plate trolley





CP 1441 - CP 1441C



CP 1441

CP 1441C

- IT** Carrelli per il trasporto piatti. Struttura in tubo di acciaio inox - ripiano portapiatti e pannellatura in lamiera di acciaio inox - ruote multidirezionali ø 125 mm.
- EN** Dish transport trolleys. Structure in stainless steel tube - stainless steel plate shelf and panelling - multidirectional wheels ø 125 mm.
- FR** Chariots pour transporter la vaisselle. Structure en tube d'acier inox - étagère et revêtement en tôle d'acier inox - roues multidirectionnelles ø 125 mm.
- DE** Geschirrwagen. Edelstahlrohrstruktur - Tellerablage und Verkleidung aus Edelstahlblech - Mehrwegräder ø 125 mm.

	CP 1441	CP 1441C
 cm	91 x 57 x 101(h) cm	
 N.	1	2
	200 piatti / plates	
	460 €	615 €

Carrelli per il trasporto piatti
Dish transport trolleys

Optional

A 410 (mod.CA 1439-1440)	A 420 (mod.CA 1439G-1440G)
Copertura in PVC con 4 cerniere. PVC lid with 4 hinges. Couverture en PVC avec 4 charnières. PVC-Abdeckung mit 4 Scharnieren.	
300 €	340 €

A 512 (mod.CP 1441-1441C - CA 631-656)
Ruote con freno Wheels with catch Roues avec frein Räder mit Bremse
10 € cad./each

A 1001 (mod.CP 1441-1441C)	A 1002 (mod.CP 1441-1441C)
Cestino piccolo Small basket Petit panier Klein Korb	Cestino grande Big basket Grand panier Gros Korb
10 €	25 €





HE290 - HE540

New

IMPORTED









IT Carrelli portateglie GN1/1 e GN2/1 armadiati e riscaldati. Struttura ed interno in acciaio INOX AISI 304 - maniglie laterali per conduzione carrello - porte non reversibili - isolamento 60 mm - riscaldamento ventilato - termostato di tipo meccanico - mantiene 70°C di temperatura fino ad un'ora dallo spegnimento - ruote multidirezionali \varnothing 125 mm di cui due con freno.

EN Heated GN1/1 and GN2/1 cupboard trolleys. Stainless steel AISI 304 structure and interior - side handles for trolley guidance - non-reversible doors - 60 mm insulation - ventilated heating - mechanical thermostat - maintains 70°C temperature up to one hour after switching off - multi-directional wheels \varnothing 125 mm, two of which with brake.

FR Chariots chauffés sur élément fermé GN1/1 et GN2/1. Structure et intérieur en acier inox AISI 304 - poignées latérales pour le déplacement du chariot - portes non réversibles - isolation de 60 mm - chauffage ventilé - thermostat mécanique - maintien de la température à 70°C jusqu'à une heure après l'arrêt - roues multidirectionnelles \varnothing 125 mm, dont deux avec frein.

DE Beheizte GN1/1 und GN2/1 Wagen mit Schrankelement. Struktur und Innenraum aus Edelstahl AISI 304 - seitliche Lenkgriffe für die Führung des Wagens - nicht umkehrbare Türen - 60 mm Isolierung - belüftete Heizung - mechanischer Thermostat - hält die Temperatur von 70°C bis zu einer Stunde nach dem Ausschalten aufrecht - Mehrzweckräder \varnothing 125 mm, zwei davon mit Bremse.

	HE290	HE540
	HE290	HE540
	800 W	1500 W
	220-240V/1N/50-60 Hz	
	+30° +90°C	
	290 L - GN1/1 - 20 pcs	540 L - GN2/1 - 20 pcs
	83 x 67,2 x 177,6(h) cm	95 x 87,7 x 177,6(h) cm
	650 x 395 x 1430(h) mm	770 x 600 x 1430(h) mm
	1.485 €	1.750 €

Carrelli portateglie GN1/1 - GN2/1 armadiati e riscaldati
Heated GN1/1 and GN2/1 cupboard trolleys.

CG 1439A



GRIGLIA
VERNICIATA
PAINTED
GRID



IT Carrelli portapiatti armati. Struttura portante in acciaio plastificato - telaio in alluminio anodizzato - pannellatura in perflex con 4 sportelli apribili in plexiglass - griglie verniciate o cromate - maniglie laterali per conduzione carrello - ruote multidirezionali \varnothing 125 mm di cui due con freno.

EN Cabinet plate trolleys. Supporting structure in plastic-coated steel - anodized aluminium frame - perflex panelling with 4 openable Plexiglas doors - painted or chrome-plated grids - side handles for trolley operation - multidirectional wheels \varnothing 125 mm, two of which with brakes.

FR Chariots porte-assiettes sur élément fermé. Structure portante en acier plastifié - corps en aluminium anodisé - panneaux en perflex avec 4 portes ouvrantes en plexiglas - grilles peintes ou chromées - poignées latérales pour le déplacement - roues multidirectionnelles \varnothing 125 mm dont deux avec frein.

DE Tellerwagen mit Schrankelement. Tragstruktur aus kunststoffbeschichtetem Stahl - Rahmen aus eloxiertem Aluminium - Blenden in Perflex mit 4 Flügeltüren aus Plexiglas - lackierte oder verchromte Gitter - seitliche Lenkergriffe - Mehrwegräder \varnothing 125 mm, zwei davon mit Bremsen.

	CG 1439A griglie verniciate / painted grid
	75 x 78 x 170(h) cm
	10 griglie verniciate GN2/1 - 10 painted grids GN2/1
	1.920 €

CA 1439A CA 1440A CA 1439AG CA 1440AG



GRIGLIA
VERNICIATA
PAINTED
GRID



GRIGLIA
CROMATA
CHROME
PLATED GRID

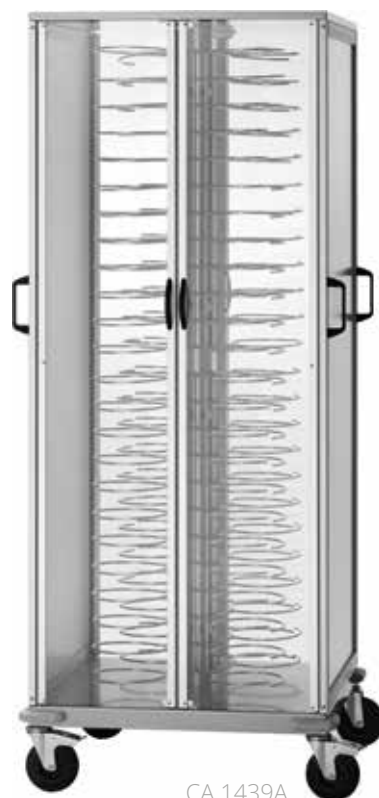

CA 1439A

	CA 1439A griglie verniciate painted grid	CA 1440A griglie cromate chrome-plated grill	CA 1439AG griglie verniciate painted grid	CA 1440AG griglie cromate chrome-plated grill
	75 x 78 x 183(h) cm			
	88 piatti / plates \varnothing 18/23 cm	88 piatti / plates \varnothing 18/23 cm	88 piatti / plates \varnothing 25/31 cm	88 piatti / plates \varnothing 25/31 cm
	1.775 €	1.825 €	1.805 €	1.855 €

CG 1439AC

GRIGLIA
VERNICIATA
PAINTED
GRID



IT Carrelli portapiatti armadiati e riscaldati. Struttura portante in acciaio plastificato - termostato regolabile - telaio in alluminio anodizzato - pannellatura in PERFEX con n. 4 sportelli apribili in plexiglass - griglie verniciate o cromate maniglie laterali per conduzione carrello - ruote ø 125 mm di cui due con freno.

EN Heated cabinet plate trolleys. Supporting structure in plastic-coated steel - adjustable thermostat - anodized aluminium frame - perfix panelling with 4 openable Plexiglas doors - painted or chrome-plated grids - side handles for trolley operation - multidirectional wheels ø 125 mm, two of which with brakes.

FR Chariots porte-assiettes chauffantes sur élément fermé. Structure portante en acier plastifié - thermostat réglable - corps en aluminium anodisé - panneaux en PERFEX avec 4 portes ouvrables en plexiglas - grilles chromées - poignées latérales pour le déplacement - roues ø 125 mm, dont deux avec frein.

DE Beheizter Tellerwagen und mit Schrankelement. Tragstruktur aus Kunststoffbeschichtetem Stahl. Einstellbarer Thermostat Rahmen aus eloxiertem Aluminium. Blenden in Perfex mit 4 Flügeltüren aus Plexiglas. Verchromte Gitter Seitliche Lenkergriffe - Räder diam. 125 mm, zwei davon mit Bremsen.

	CG 1439AC	
	800 + 800 W	
	220-240V/1N/50-60 Hz	
	max 60°C	
	10 griglie verniciate GN2/1 / 10 painted grids GN2/1	
	75 x 78 x 177(h) cm	
	2.790 €	

CA 1440AC CA 1440ACG

GRIGLIA
CROMATA
CHROME
PLATED GRID



	CA 1440AC	CA1440ACG
	800 + 800 W	
	220-240V/1N/50-60 Hz	
	max 60°C	
	88 piatti / plates ø 18/23 cm	88 piatti / plates ø 25/31 cm
	75 x 78 x 177(h) cm	
	2.570 €	2.600 €

Carrelli portapiatti armadiati riscaldati
Heated cabinet plate trolleys

CA 1439R CA 1439RG

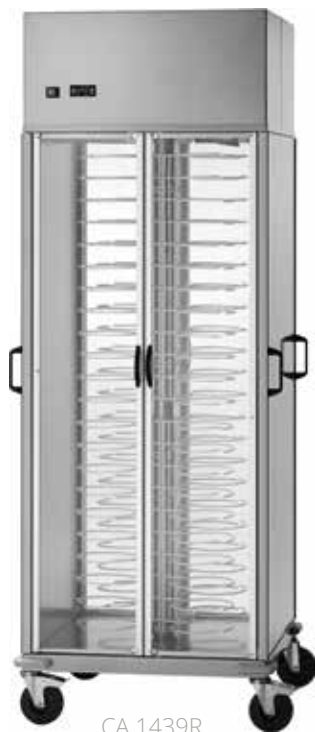

CA 1439R

IT Carrelli portapiatti refrigerati. Struttura portante in acciaio plastificato - telaio in alluminio anodizzato - pannellatura in isomac spessore 25 mm con 4 sportelli apribili in plexiglass- griglie plastificate - maniglie laterali per conduzione carrello - ruote ø 125 mm di cui due con freno.

EN Refrigerated cabinet plate trolleys Supporting structure in plastic-coated steel - anodized aluminium frame - isomac panelling with 25 mm thickness and 4 openable Plexiglas doors - plastic coated grids - side handles for trolley operation - multidirectional wheels ø 125 mm, two of which with brakes.

FR Chariots porte-assiettes réfrigérées. Structure portante en acier plastifié - corps en aluminium anodisé - panneaux en isomac épaisseur 25 mm avec 4 portes ouvrantes en plexiglas - grilles plastifiées - poignées latérales pour le déplacement - roues ø 125 mm dont deux avec frein.

DE Gekühlte Tellerwagen. Tragstruktur aus kunststoffbeschichtetem Stahl - Rahmen aus eloxiertem Aluminium - 25 mm starke Isomac-Blenden mit 4 Flügeltüren aus Plexiglas - kunststoffbeschichtete Gitter - seitliche Lenkergriffe - Räder ø 125 mm, zwei davon mit Bremsen.

CG 1439R



	CA 1439R	CA 1439RG	CG 1439R
	460 W		
	220-240V/1N/50-60 Hz		
	+8°C - +12 °C		
	R290		
	88 piatti / plates ø 18/23 cm	88 piatti / plates ø 25/31 cm	10 griglie x GN2/1 10 grills x GN2/1
	75 x 78 x 203(h) cm		
	3.000 €	3.050 €	3.190 €

CA 656 - CA 631



IT Carrelli per ritiro, distribuzione e stoccaggio vassoi, piatti, tazze, ecc. Telaio in acciaio inox - cesti asportabili in filo di acciaio plastificato - paracolpi - ruote multidirezionali ø 125 mm.

EN Trolleys for collecting, distributing and storing trays, plates, cups, etc. Stainless steel frame - removable baskets made of plastic-coated steel wire - shock absorbers - multidirectional wheels ø 125 mm.

FR Chariots de collecte, de distribution et de stockage de plateaux, assiettes, tasses, etc. Structure en acier inox - paniers amovibles en fil d'acier plastifié - butoirs - roues multidirectionnelles ø 125 mm.

DE Wagen zum Sammeln, Verteilen und Lagern von Tablett, Tellern, Tassen usw. Edelstahlrahmen - abnehmbare Körbe aus kunststoffbeschichtetem Stahldraht - Stoßschutz - Mehrwegräder ø 125 mm.

	CA 656	CA 631
	88 x 50 x 92(h) cm	75 x 65 x 92(h) cm
	1 cesto / basket	1 cesto / basket
	100 piatti / plates ø23 cm	130 vassoi / trays 53x32,5 / 37x53cm
	440 €	360 €

Carrelli portapiatti per trasporto e ritiro
Plates transport and collection trolleys

CA 1399 CA 1400 CA 1401



CA 1400

CA 1401

IT Carrelli scolapiatti e bicchieri. Telaio in tubo di acciaio inox - ripiani con griglie in acciaio inox per piatti - vaschette scola bicchieri in acciaio inox - piano raccogliacqua in acciaio inox - ruote multidirezionali ø 125 mm.

EN Plates and glasses drainer trolleys. Stainless steel tubular frame - shelves with stainless steel grids for plates - stainless steel glass draining trays - stainless steel drip tray - multidirectional wheels ø 125 mm.

FR Chariots égouttoir assiettes et verres. Structure en tube d'acier inox - étagères avec grilles en acier inox pour assiettes - plateaux d'égouttage pour les verres en acier inox - cuve de récupération en acier inox - roues multidirectionnelles ø 125 mm.

DE Geschirr und Gläser Abtropfwagen. Edelstahlrohrrahmen - Stellflächen mit Edelstahlgittern für Teller - Abtropfschalen für Gläser aus Edelstahl - Tropfschale aus Edelstahl - Mehrwegräder ø 125 mm.

	CA 1399	CA 1400	CA 1401
	110 x 62 x 134(h) cm		110 x 62 x 160(h) cm
	3 scolapiatti 3 plates drainers ø23 cm	1 scolabicchieri 1 glasses drainer 2 scolapiatti 2 plates drainers	4 scolapiatti 4 plates drainers
	770 €	835 €	950 €

Scolapiatti e bicchieri
Plates and glasses drainer

SPB 1398



SP 1397



IT Pensili scolapiatti e bicchieri da muro. Struttura in acciaio inox lucido 18/8.

EN Hanging plates and glasses drainer. Structure in 18/8 polished stainless steel.

FR Égouttoir mural pour assiettes et verres. Structure en acier inox poli 18/8.

DE Geschirr und Gläser Wandabtropfschränke. Struktur aus poliertem Edelstahl 18/8.

	SPB 1398	SP 1397
	80 x 26 x 37(h) cm ø23 cm	104 x 30 x 55(h) cm ø23 cm
	95 €	215 €

CP 1442



IT Carrello portacestelli per lavastoviglie. Struttura tubolare in acciaio inox 50x50 cm. Ruote multidirezionali ø 125 mm - cestelli non inclusi.

EN Dishwasher trolley. Stainless steel tubular structure 50x50 cm. Multidirectional wheels ø 125 mm - baskets not included.

FR Chariot pour lave-vaisselle. Structure tubulaire en acier inox 50x50 cm. Roues multidirectionnelles ø 125 mm - paniers pas compris.

DE Spülmaschinenwagen. 50x50 cm Edelstahlrohrstruktur. Mehrwegräder ø 125 mm - Körbe nicht enthalten.

	CP1442
	65 x 65 x 170(h) cm
	305 €

 118 Scolapiatti e bicchieri
Plates and glasses drainer

Carrello portacestelli
Basket trolley

CP 1447 CP 1448



CP 1447

CP 1445 CP 1446



CP 1445

IT Carrelli portacestelli per lavastoviglie. Vasca in ABS - disponibile con o senza manico in acciaio inox - ruote multidirezionali ø 125 mm - cestelli non inclusi.

EN Dishwasher basket trolleys. ABS base - available with or without stainless steel handle - multidirectional wheels ø 125 mm - baskets not included.

FR Chariots porte-paniers pour lave-vaisselle. Fond en ABS - disponible avec ou sans poignée en acier inox - roues multidirectionnelles ø 125 mm - paniers pas compris.

DE Korbwagen für Geschirrspülerkörbe. ABS-Boden - mit oder ohne Edelstahlgriff erhältlich - Mehrwegräder ø 125 mm - Körbe nicht enthalten.

IT Carrelli portacestelli per lavastoviglie. Vasca in acciaio inox - disponibile con o senza manico in acciaio inox - ruote multidirezionali ø 125 mm di cui due con freno. Ceste non incluse.

EN Dishwasher basket trolleys. Stainless steel base - available with or without stainless steel handle - multidirectional wheels ø 125 mm, 2 of which fixed. Baskets not included.

FR Chariots porte-paniers pour lave-vaisselle. Fond en acier inox - disponible avec ou sans poignée en acier inox - roues ø 125 mm, dont deux avec frein. Paniers pas compris.

DE Korbwagen für Geschirrspülerkörbe. Edelstahl Boden - mit oder ohne Edelstahlgriff erhältlich - Mehrwegräder, davon 2 mit Bremse, Körbe nicht enthalten.

	CP 1447 con manico - with handle	CP 1448 senza manico - without handle
	53 x 56 x 92(h) cm	53 x 56 x 21(h) cm
	140 €	95 €

	CP 1445 con manico - with handle	CP 1446 senza manico - without handle
	52 x 58 x 96(h) cm	52 x 52 x 20(h) cm
	270 €	235 €

Carrello portacestelli
Basket trolley

CB 1444 - CB 1443



CB 1444

IT Carrelli per impasti pizza con cassette da 60x40 cm - interamente in acciaio inox - disponibile con o senza manico in acciaio inox - ruote multidirezionali ø 125 mm di cui due con freno.

EN Pizza dough trolleys with 60x40 cm containers - entirely made of stainless steel - available with or without stainless steel handle - roues ø 125 mm, dont deux avec frein.

FR Chariots à pâte à pizza avec bacs de 60x40 cm - entièrement en acier inox - disponible avec ou sans poignée en acier inox - multidirectional wheels ø 125 mm, 2 of which fixed.

DE Pizzateigwagen mit 60x40 cm Behälter - komplett aus Edelstahl - mit oder ohne Edelstahlgriff erhältlich - Mehrwegräder ø 125 mm, davon 2 mit Bremse.

	CB 1444 con manico - with handle	CB 1443 senza manico - without handle
	72 x 42 x 96(h) cm	62 x 42 x 20(h) cm
	270 €	245 €

CB 1449



IT Carrello portacassette per impasti pizza 60x40 cm - senza manico - vasca in ABS - ruote multidirezionali ø 125 mm.

EN Trolley for Pizza dough containers 60x40 cm - without handle - ABS base - multidirectional wheels ø 125 mm.

FR Chariot à bacs pour pâte à pizza 60x40 cm - sans poignée - fond en ABS - roues multidirectionnelles ø 125 mm.



DE Wagen für Pizzateigbehälter 60x40 cm - ohne Griff - ABS-Boden - Mehrwegräder ø 125 mm.

	CB 1449
	62 x 42 x 16,5(h) cm
	80 €

Cestelli per lavastoviglie 50x50 cm

Dishwasher baskets 50x50 cm
 Paniers pour lave-vaisselle 50x50 cm
 Körbe für Geschirrspüler 50x50 cm



	BVM	BV	B9	B16	B25	B36	B49	BP	BA
	base vuota h 88 mm col. grigio per posate	base vuota h 88 mm col. grigio universale	base 9 scomparti h 88 mm col. grigio (bicchiere diam. 150 mm)	base 16 scomparti h 88 mm col. grigio (bicchiere diam. 110 mm)	base 25 scomparti h 88 mm col. grigio (bicchiere diam. 89 mm)	base 36 scomparti h 88 mm col. grigio (bicchiere diam. 73 mm)	base 49 scomparti h 88 mm col. grigio (bicchiere diam. 62 mm)	base per piatti o vassoi h 88 mm col. grigio	base per vassoi aperto su un lato h 88 mm col. grigio
	50 x 50 x 10,6(h) cm								
	23 €	23 €	25 €	26 €	28 €	29 €	32 €	24 €	21 €

	RIAU	RIA9	RIA25	RIA36	RIA49	RIA16	CP8	COPCEST
	rialzo universale h 42 mm col. blu	rialzo 9 scomparti h 42 mm col. blu	rialzo 25 scomparti h 42 mm col. blu	rialzo 36 scomparti h 42 mm col. blu	rialzo 49 scomparti h 42 mm col. blu	rialzo 16 scomparti h 42 mm col. blu	cestellino inserto portaposate 8 scomparti	coperchio standard per cestelli
	50 x 50 x 5(h) cm						-	-
	12 €	13 €	13 €	15 €	14 €	13 €	15 €	17 €

DISPONIBILI ALTRI PRODOTTI NEL CATALOGO FIMAR
AVAILABLE OTHER PRODUCTS ON FIMAR CATALOGUE



Cestelli per lavastoviglie
 Dishwasher baskets



Carrelli e articoli per il servizio in camera

TROLLEYS AND EQUIPMENT
FOR ROOM SERVICE
CHARIOTS ET ARTICLES
DE ROOM SERVICE
WAGEN UND AUSRÜSTUNG
FÜR DEN ZIMMERSERVICE

CB 980



NOCE/WALNUT



CARBON



CB 980

CB 980 CA

Esclusa cassetta
Boxes not included

CB 970



NOCE/WALNUT



CARBON



CB 970 CA

CB 970

IT Carrelli per la colazione. Struttura portante in tubo di acciaio inox - ripiano con antine ribaltabili in nobilitato - ripiano di servizio ruotabile sino a 90°, con possibilità di incastrare i carrelli uno dentro l'altro per ridurre al minimo l'ingombro. Ruote multidirezionali di cui 2 con freno.

EN Breakfast trolleys. Supporting structure in stainless steel tube - shelf with melamine folding doors - service shelf that can be rotated up to 90°, trolleys can be pushed one inside the other to reduce the overall dimensions considerably. Multidirectional wheels, 2 with brake.

FR Chariots pour le petit déjeuner. Structure portante en tube d'acier inox - plan de travail avec volets en mélaminé - plan de service pivotant jusqu'à 90°, les chariots peuvent être rangés les uns dans les autres pour réduire l'encombrement au minimum. Roues multidirectionnelles, dont 2 avec frein.

DE Frühstückswagen. Tragstruktur aus Edelstahlrohr - Abstellfläche mit Klapptüren aus Melamin - bis zu 90° drehbare Ablagefläche, Wagen ineinander stapelbar, um die Außenmaße höchst möglichst zu reduzieren. Mehrwegräder, davon 2 mit Bremse.

	CB 980 noce-walnut	CB 980 CA carbon
	Open ø 80 x 80(h) cm Closed 80 x 53 x 80(h) cm	
	540 €	

	CB 970 noce-walnut	CB 970 CA carbon
	Open 80 x 53 x 80(h) cm Closed 35 x 53 x 80(h) cm	
	540 €	

Carrelli per la colazione
Breakfast trolleys

CST 300



IT Cassetta termica per scaldare piatti e prime colazioni. Contenitore interamente in acciaio inox - piano intermedio - termostato regolabile.

EN Heating box to warm plates and breakfasts. Container entirely in stainless steel - intermediate shelf - adjustable thermostat

FR Boîte thermique pour réchauffer les assiettes et les petits déjeuners. Corps entièrement en acier inox - étagère intermédiaire - thermostat réglable.

DE Wärmekiste zum Erwärmen von Teller und Frühstück. Kiste komplett aus Edelstahl - Zwischenboden - einstellbarer Thermostat.

	CST 300
	250 W
	220-240V/1N/50-60 Hz
	+30° +60°C
	39 x 37 x 46(h) cm - n.2 piatti /plates ø 33 cm
	350 €

CPC 600

Cassette termiche non incluse
Boxes not included



IT Carrello porta cassette termiche Mod. CST300 con allacciamento elettrico. Struttura tubolare 25x25 cm in acciaio inox - guide per contenere n.6 cassette termiche. Ruote ø 125 mm di cui 2 con freno. Cassette non incluse.

EN Heating boxes trolley Mod. CST300 with electrical connection. Tubular structure 25x25 cm in stainless steel - slides to store 6 heating boxes. Wheels ø 125 mm 2 of which with brake. Boxes not included.

FR Chariot à boîtes thermiques Mod. CST300 avec connexion électrique. Structure en tube d'acier inox 25x25 cm - glissières pour contenir 6 boîtes thermiques. Roues ø 125 mm dont 2 avec frein. Boîte pas compris.

DE Wagen für Wärmekiste Mod. CST300 mit elektrischem Anschluss. Rohrstruktur 25x25 cm aus Edelstahl - Führungen für 6 Wärmekisten. Räder ø 125 mm davon 2 mit Bremse. Wärmekisten nicht enthalten.

	CPC 600
	220-240V/1N/50-60 Hz
	155 x 61 x 132(h) cm - ø 33 cm
	520 €

PV4064R

PV4064

PV4056R

PV4056



IT Carrelli portavaligie e portabiti. Base in legno ricoperta da moquette colorata, disponibile nei colori rosso o blu - supporto asta in tubolare di acciaio cromato da \varnothing 40 mm - bordo paracolpi perimetrale in gomma - ruote multidirezionali \varnothing 200 mm.

FR Chariots à bagages et porte-vêtements. Base en bois recouverte de moquette, disponible en rouge ou bleu - Support en tube d'acier tubulaire chromé \varnothing 40 mm - Bord de butoir périphérique en caoutchouc - Roues multidirectionnelles \varnothing 200 mm.

EN Luggage trolleys and clothes racks. Wooden base covered with coloured carpet, available in red or blue - rod support in chrome-plated steel tube \varnothing 40 mm - perimeter rubber shock absorber - multidirectional wheels \varnothing 200 mm.

DE Kofferwagen und Kleiderständer. Holzboden mit buntem Teppichboden, erhältlich in den Blau - Stabhalterung aus vermessingt oder verchromtem Stahlrohr \varnothing 40 mm - Gummistoßschutz - Mehrrichtungsräder \varnothing 200 mm.

i	PV 4064R	PV 4064	PV 4056R	PV 4056
↗ cm	95 x 55 x 190(h) cm		95 x 55 x 183(h) cm	
	Base rossa + Struttura cromata Red base + Chromed structure	Base blu + Struttura cromata Blue base + Chromed structure	Base rossa + Struttura cromata Red base + Chromed structure	Base blu + Struttura cromata Blue base + Chromed structure
MAX Kg	150 Kg			
	1.265 €		1.045 €	

Carrelli portavaligie e portabiti
Luggage trolleys and clothes racks

PV 2001

PV 2001I

PV 2021

PV 2021I



WARNING



IT Carrelli portavaligie e portabiti. Base in legno ricoperta da moquette colorata, disponibile in rosso - supporto asta in tubolare di acciaio ottonato o inox da \varnothing 40 mm - bordo paracolpi perimetrale in gomma - ruote multidirezionali \varnothing 200 mm.

EN Luggage trolleys and clothes racks. Wooden base covered with coloured carpet, available in red - rod support in brass-plated steel or stainless steel tube \varnothing 40 mm - perimeter rubber shock absorber - multidirectional wheels \varnothing 200 mm.

FR Chariots à bagages et porte-vêtements. Base en bois recouverte de moquette, disponible en rouge - support en tube d'acier tubulaire en laiton ou acier inox \varnothing 40 mm - bord de butoir périphérique en caoutchouc - roues multidirectionnelles \varnothing 200 mm.

DE Chariots à bagages et porte-vêtements. Base en bois recouverte de moquette, disponible en rouge - support en tube d'acier tubulaire en laiton ou acier inox \varnothing 40 mm - bord de butoir périphérique en caoutchouc - roues multidirectionnelles \varnothing 200 mm.

IT Carrelli portavaligie e portabiti. Base in legno ricoperta da moquette colorata, disponibile nei colori rosso o nera - supporto asta in tubolare di acciaio ottonato o inox da \varnothing 40 mm - bordo paracolpi perimetrale in gomma - ruote pneumatiche \varnothing 200 mm.

EN Luggage trolleys and clothes racks. Wooden base covered with coloured carpet, available in red or black - rod support in brass-plated steel or stainless steel tube \varnothing 40 mm - perimeter rubber shock absorber - pneumatic wheels \varnothing 200 mm.

FR Chariots à bagages et porte-vêtements. Base en bois recouverte de moquette, disponible en rouge ou noir - support en tube d'acier tubulaire en laiton ou acier inox \varnothing 40 mm - bord de butoir périphérique en caoutchouc - roues pneumatiques \varnothing 200 mm.

DE Kofferwagen und Kleiderständer. Holzboden mit buntem Teppichboden, erhältlich in den Farben Rot oder Schwarz - Stabhalterung aus vermessingt Stahl oder Edelstahlrohr \varnothing 40 mm - Gummistoßschutz - Lufräder \varnothing 200 mm.

i	PV 2001	PV 2001I
↗ cm	124 x 64 x 190(h) cm	
	Base rossa + Struttura ottone Red base + Brass structure	Base rossa + Struttura inox Red base + Stainless steel structure
MAX Kg	150 Kg	
	1.140 €	1.050 €

i	PV 2021	PV 2021I
↗ cm	110 x 62 x 198(h) cm	
	Base rossa + Struttura ottone Red base + Brass structure	Base nero + Struttura inox Black base + Stainless steel structure
MAX Kg	150 Kg	
	1.110 €	995 €

126 Carrelli portavaligie e portabiti
Luggage trolleys and clothes racks



IL CARRELLO VIENE SPEDITO IN KIT SMONTATO
THE TROLLEY IS DELIVERED DISMOUNTED
LE CHEROIT EST LIVRÉ DEMONTÉ
DER WAGEN IST DEMONTIERT GELIEFERT

PV 2002



PV 2002I



PV 2003



PV 2003I



IT Carrelli portavaligie. Base pieghevole e piani in legno ricoperti di moquette colorata rossa - struttura disponibile in acciaio ottonato o inox - 2 piedi di appoggio - ruote ø 250 mm.

FR Chariot à bagages. Base repliable et étagères en bois recouvertes de moquette de couleur rouge - structure disponible en acier laitoné ou en acier inox - 2 pieds de support - roues ø 250 mm.

EN Luggage trolleys. Foldable base and wooden shelves covered with red carpet - structure available in brass or stainless steel - 2 support feet - wheels ø 250 mm.

DE Kofferwagen. Klappboden und Holzabstellflächen mit rotem Teppichboden - Struktur wahlweise aus vermessingtem Stahl oder Edelstahl - 2 Standfüße - Räder ø 250 mm.

i	PV 2002	PV 2002I	PV 2003	PV 2003I
↗ cm	56 x 83 x 123(h) cm		56 x 70 x 120(h) cm	
	Base rossa + Struttura ottone Red base + Brass structure	Base rossa + Struttura inox Red base + Stainless steel structure	Base rossa + Struttura ottone Red base + Brass structure	Base rossa + Struttura inox Red base + Stainless steel structure
MAX Kg	100 Kg			
	315 €	280 €	250 €	225 €

Carrelli portavaligie
Luggage trolleys

PVI 4024



IT Carrello portavaligie e portabiti. Struttura in tubo di acciaio inox - base in lamiera d'acciaio inox - ruote multidirezionali \varnothing 140 mm, di cui 2 fisse.

EN Luggage trolley and clothes rack Structure in stainless steel tube - base in stainless steel plate - multidirectional wheels \varnothing 140 mm, 2 of which fixed.

FR Chariots à bagages et porte-vêtements. Structure en tube d'acier inox - base en tôle d'acier inox - roues multidirectionnelles \varnothing 140 mm, dont 2 fixes.

DE Kofferwagen und Kleiderständer. Struktur aus Edelstahlrohr - Boden aus Edelstahlblech - Mehrwegräder \varnothing 140 mm, 2 davon fest.

ST 4060

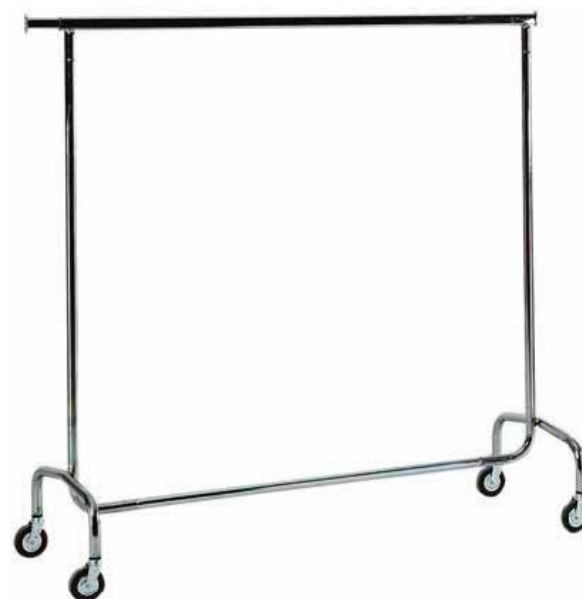

IT Stender portabiti. Struttura in tubo di acciaio cromato - asta allungabile di 30 cm per lato - ruote multidirezionali.

EN Clothes rack. Chrome-plated steel tube structure - rod can be extended by 30 cm on each side - multidirectional wheels.

FR Vêtements rack. Structure en tube d'acier chromé - bras extensible de 30 cm de chaque côté - roues multidirectionnelles.

DE Kleiderständer. Verchromte Stahlrohrstruktur - der Stab lässt sich auf jeder Seite um 30 cm verlängern - Mehrwegräder.

	PVI 4024
	100 x 56 x 160(h) cm
	200 Kg
	410 €

	ST 4060
	Open 210 x 53 x 152(h) cm Closed 150 x 53 x 152(h) cm
	110 €

CPB 1472 - CPB 1474



- IT** Carrelli per trasporto pesante. Pianale basso in lamiera di acciaio inox - manico smontabile - ruote multidirezionali ø 140 mm di cui 2 fisse e dotate di freno.
- EN** Trolleys for heavy transport Lower platform in stainless steel plate - removable handle - multidirectional wheels ø 140 mm, 2 of which fixed and equipped with brake.
- FR** Chariot de transport lourd. Etagère basse en tôle d'acier inox - poignée amovible - roues multidirectionnelles ø 140 mm, dont 2 fixes et équipées de freins.
- DE** Wagen für den Schwertransport. Niedrige Ladefläche aus Edelstahlblech - abnehmbarer Griff - Mehrwegräder ø 140 mm, 2 davon fest und mit Bremse ausgestattet.



	CPB 1474	CPB 1472
	61 x 122 x 90(h) cm	61 x 110 x 85(h) cm
	1 manico 1 handle	2 manici 2 handles
	200 Kg	
	420 €	395 €

Carrelli per trasporto pesante
Trolleys for heavy transport

AC 5118D AC 5118I



IT Aste delimita corsie per cordoni a treccia. Puntali in abbinamento.
 EN Barriers posts for plaited cords. Matching caps.
 FR Délimiteur de zone pour cordons tressés. Pointe coordonnée.
 DE Begrenzungspfosten für geflochtene Seile. Passende Spitzen.

	AC 5118D	AC 5118I
	90(h) cm	
	Asta dorata Golden post	Asta acciaio lucido Polished steel post
	90 €	

PU 5144D - PU 5144I

IT Puntali in abbinamento delle aste delimita corsie per cordoni a treccia.
 EN Caps matching the posts of the barriers with plaited cords.
 FR Pointes coordonnées avec les mâts pour cordons tressés.
 DE Spitzen passend zu den Begrenzungspfosten für geflochtene Seile.



	PU 5144D	PU 5144I
	Puntale dorato Gold cap	Puntale acciaio lucido Polished steel cap
	25 €	



GA 5144D - GA 5144I

IT Gancio a muro, disponibile in colore ottonato o cromato.
 EN Wall ring, available in brass or chrome colour.
 FR Anneau à mur, disponible en couleur laiton ou chromé.
 DE Wandhaken, erhältlich in vermessingter oder verchromter Farbe.

	GA 5144D	GA 5144I
	Gancio ottonato Brass-plated wall ring	Gancio inox Stainless steel wall ring
	22 €	



CO 4099

IT Cordone per aste. Colori: bordeaux, oro, verde, blu.
 EN Barriers cord. Colours: burgundy, gold, green, blue.
 FR Cordon pour délimiteur. Couleurs: bordeaux, or, vert, bleu.
 DE Begrenzungseile. Farben: Burgunder, Gold, Grün, Blau.

	CO 4099
	ø 30 mm
	45 € al metro / meter

ACF 5190



IT Aste delimita corsie. Disponibili in diverse misure con nastro avvolgibile colorato rosso o blu - asta colore oro, acciaio inox o nera. Puntali in abbinamento.

EN Retractable Barriers Available in different sizes with red or blue colored retractable belts - gold, stainless steel or black post. Matching caps.

FR Délimiteur de zone. Disponible en différentes tailles avec ruban roulant de couleur rouge ou bleue - mât en or, acier inox ou noir. Pointe coordonnée.

DE Begrenzungspfosten. Erhältlich in verschiedenen Größen mit rotem oder blauem Aufrollband - Gold, Edelstahl oder schwarze Pfosten. Passende Spitzen.



PU 5195

IT Puntali in abbinamento delle aste delimita corsie a seconda del colore e materiale scelto.

EN Caps matching the posts of the retractable barriers according to the colour and material chosen.

FR Pointes coordonnées avec les mâts de délimitation des voies en fonction de la couleur et du matériau choisi.

DE Spitzen passend zu den Begrenzungspfosten je nach Farbe und Material.

i	PU 5195 DB Blu-Blue	PU 5195 DR Rosso-Red	PU 5195 IB Blu-Blue	PU 5195 IR Rosso-Red	PU 5195 NB Blu-Blue	PU 5195 NR Rosso-Red
	Puntale dorato Gold cap		Puntale acciaio lucido Polished steel cap		Puntale nero Black cap	
	40 €					

i	ACF 5190 DB Blu-Blue	ACF 5190 DR Rosso-Red
↗ cm	2 mt	
	Asta dorata Golden post	
i	ACF 5190 IB Blu-Blue	ACF 5190 IR Rosso-Red
↗ cm	2 mt	
	Asta acciaio lucido Polished steel post	
i	ACF 5190 NB Blu-Blue	ACF 5190 NR Rosso-Red
↗ cm	2 mt	
	Asta nera Black post	
	90 €	

Aste delimita corsia
Retractable barriers



Carrelli portabiancheria

rifornimento frigobar, pulizia e multiuso

LAUNDRY, MINIBAR, CLEANING
AND MULTI-PURPOSE TROLLEYS.
CHARIOTS À LINGE, REPLISSAGE MINIBAR,
NETTOYAGE ET POLYVALENT.
WÄSCHEREI-, MINIBAR-, REINIGUNGS- UND
MEHRZWECKWAGEN.

CA 1505



CA 1505

CA 1505 CA

CA 1510

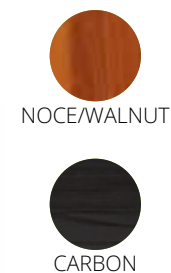

NOCE/WALNUT

CARBON

CA 1515



IT Carrelli portabiancheria. Struttura in acciaio inox - piani in laminato - in dotazione un sacco in tessuto ignifugo - paracolpi in gomma - ruote multidirezionali ø 125 mm.

EN Laundry trolleys. Stainless steel structure - laminate shelves - fireproof fabric bag included - rubber shock absorbers - multidirectional wheels ø 125 mm.

FR Chariots à linge. Structure en acier inox - dessus en stratifié - sac en tissu ignifuge inclus - butoir en caoutchouc - roues multidirectionnelles ø 125 mm.

DE Wäschereiwagen. Edelstahlstruktur - Laminatoberflächen - feuerfester Gewebesack inbegriffen - Gummistoßschutz - Mehrwegräder ø 125 mm.

	CA 1505 noce-walnut	CA 1505 CA carbon	CA 1510 noce-walnut	CA 1510 CA carbon	CA 1515 noce-walnut	CA 1515 CA carbon
	70/100 x 50 x 123(h) cm		90/143 x 50 x 123(h) cm		110/143 x 50 x 123(h) cm	
	4		4		4	
	1 braccio pieghevole 1 folding arm		2 braccia pieghevoli 2 folding arms		2 braccia pieghevoli 2 folding arms	
	645 €		650 €		660 €	

Carrelli portabiancheria
Laundry trolleys

OPTIONAL



CA 1525



INOX



IT Carrello portabiancheria. Struttura in acciaio inox - piani in acciaio inox - 2 portasacchi, in dotazione un sacco in tessuto ignifugo - cassetto superiore porta accessori in acciaio inox - paracolpi in gomma - ruote multidirezionali ø 125 mm.

EN Laundry trolley. Stainless steel structure - stainless steel shelves - 2 bag holders, supplied with a fireproof fabric bag - stainless steel upper drawer for accessories - rubber shock absorber - multidirectional wheels ø 125 mm.

FR Chariot à linge. Structure en acier inox - étagères en acier inox - 2 porte-sacs, fournis avec un sac en tissu ignifugé - tiroir supérieur porte-accessoires en acier inox - butoir en caoutchouc - roues multidirectionnelles ø 125 mm.

DE Wäschereiwagen. Edelstahlstruktur - Edelstahloberflächen - 2 Sackhalter, feuerfester Gewebesack inbegriffen - obere Schublade aus Edelstahl für Zubehörteile - Gummistoßschutz - Mehrwegräder ø 125 mm.

CA 1530



IT Carrello portabiancheria, pulizia e multiuso. Struttura in lamiera verniciata a polveri epossidiche - 2 portasacchi, in dotazione un sacco in tessuto ignifugo - vaschetta porta detersivi superiore - ruote ø 140 mm, di cui 2 fisse e 2 girevoli.

EN Laundry, cleaning and multi-purpose trolley. Structure in epoxy powder coated sheet - 2 bag holders, supplied with a fireproof fabric bag - upper detergent tray - wheels ø 140 mm, 2 of which fixed and 2 swivelling.

FR Chariot à linge, nettoyage et polyvalent. Structure en tôle d'acier peinte avec des poudres époxydiques - 2 porte-sacs, fournis avec un sac en tissu ignifugé - plateau supérieur à détergent - roues ø 140 mm, dont 2 fixes et 2 pivotantes.

DE Wäscherei-, Reinigungs- und Mehrzweckwagen. Struktur aus mit Epoxidpulvern beschichtetem Blech - 2 Sackhalter, feuerfester Gewebesack inbegriffen - obere Waschmittelablage - Räder ø 140 mm, davon 2 fest und 2 schwenkbar.

	CA 1525 inox
	75/136 x 55 x 157,5(h) cm
	4 piani + cassetta 4 layers + upper drawers
	2 braccia pieghevoli 2 folding arms
	1.150 €

	CA 1530
	80/153 x 50 x 158(h) cm
	3 piani + 2 portasacchi 3 layers + 2 bag holders
	2 braccia pieghevoli 2 folding arms
	935 €

Optional

A 520

CA 1505 - CA 1510 - CA 1515 - CA 1525 - CA 1530

sacco in tela ignifugo
fireproof fabric bag sac
en tissu ignifugé
feuerfester Gewebesack

75 €

A 515

CA 1505 - CA 1510 - CA 1515 - CA 1525

Ruote con freno
Wheels with brake
Roues avec frein
Räder mit Bremsen

18 € cad./each

A 518

CA 1530 - CR 1696

Ruote con freno
Wheels with brake
Roues avec frein
Räder mit Bremsen



22 € cad./each



Carrelli portabiancheria, pulizia e multiuso
Laundry cleaning and multi-purpose trolleys

CR 1696





IT Carrello rifornimento frigo e multuso. Struttura in lamiera verniciata a polveri epossidiche - vaschetta laterale per la raccolta dei vuoti, asportabile - ruote ø 140 mm, di cui 2 fisse e 2 girevoli.

EN Multipurpose and mini bar filling trolley. Structure in epoxy powder coated plate - side tray for collecting dirt, removable - wheels ø 140 mm, of which 2 fixed and 2 swivelling.

FR Chariot pour le remplissage mini bar et polyvalent. Structure en tôle peinte à la poudre époxy - plateau latéral de vidange, démontable - roues de ø 140 mm, dont 2 fixes et 2 pivotantes.

DE Minibar- und Mehrzweckwagen. Struktur aus mit Epoxidpulvern beschichtetem Blech - seitliche Ablage zum Entleeren, abnehmbar - Räder ø 140 mm, davon 2 fest und 2 drehbar.

	CR 1696
	80 x 50 x 118(h) cm
	4 vaschette / side trays
	730 €

CA 3203



OPTIONAL
A 525 50x58x78(h) cm

Sacco a tela
Fabric bag
Sac de toile
Gewebesack

50 €



IT Cestone portabiancheria pieghevole con sacco in tela e ruote multidirezionali.

EN Folding laundry basket with fabric bag and multidirectional wheels.

FR Sac à linge pliable avec sac en toile et roues multidirectionnelles.

DE Faltbarer Wäschekorb mit Gewebesack und Mehrwegräder.

	CA 3203
	62 x 64 x 100(h) cm
	215 €

CA 1580

OPTIONAL A 521

Sacco a tela
Fabric bag
Sac de toile
Gewebesack

85 €



CA 1584

OPTIONAL A 531

Sacco a tela
Fabric bag
Sac de toile
Gewebesack

75 €



IT Carrello pieghevole plastificato. Struttura in tubo e tondino di acciaio elettroverniciato - ruote multidirezionali \varnothing 80 mm.

EN Plastic-coated folding basket. Structure in electro-varnished steel tube and rod - multidirectional wheels \varnothing 80 mm.

FR Corbeille pliante plastifié. Structure en tube et tige d'acier électroverniss - roues multidirectionnelles \varnothing 80 mm.

DE Faltbarer Kunststoffwäschekorb. Struktur aus elektrolackiertem Stahlrohr - Mehrwegräder \varnothing 80 mm.

IT Carrello pieghevole rinforzato con struttura tubolare \varnothing 30mm laccato - ruote a forcella \varnothing 100 mm.

EN Reinforced folding trolley with lacquered tubular structure \varnothing 30 mm - fork wheels \varnothing 100 mm.

FR Chariot pliant renforcé à structure tubulaire laquée \varnothing 30 mm - roues à fourches \varnothing 100 mm.

DE Verstärkter Klappwagen mit lackierter Rohrstruktur \varnothing 30 mm - Gabelräder \varnothing 100 mm.

	CA 1580
	80 x 51 x 72(h) cm
	135 €

	CA 1584
	100 x 60 x 87(h) cm
	360 €

Cestone e carrelli con cesto per biancheria
Basket and trolleys with laundry basket

CA 1599



IT Secchio carrellato con strizzatore 15 L. Struttura di rialzo per inserimento prodotti pulizia - manico cromato ad incastro con impugnatura in gomma antiscivolo.

EN Bucket with wringer on wheels 15 L. Elevated structure for the insertion of cleaning products - chromed handle with non-slip rubber grip.

FR Seau sur roues avec essoreuse 15 L. Structure de rehausse pour l'insertion des produits de nettoyage - manche chromé avec poignée antiglisse en caoutchouc.

DE Fahrbarer Mopp Eimer mit Presse 15 L. Erhöhte Struktur für den Einsatz von Reinigungsmitteln - verchromter Griff mit rutschfestem Gummigriff.

	CA 1599
	55 x 27 x 87(h) cm
	180 €

CA 1599E



IT Secchio carrellato con strizzatore 32 L.

EN Bucket with wringer on wheels 32 L.

FR Seau sur roues avec essoreuse 32 L.

DE Fahrbarer Mopp Eimer mit Presse 32 L.

	CA 1599E
	60 x 40 x 92(h) cm
	80 €

CA 1604



IT Secchio carrellato con strizzatore in nylon - 2 secchi da 25 L - maniglione reversibile - ruote multidirezionali da \varnothing 80 mm.

EN Bucket with nylon wringer on wheels - 2x25 L buckets - reversible handle - multidirectional wheels \varnothing 80 mm.

FR Seau sur roue avecessoreuse en nylon - 2 seaux de 25 litres - poignée réversible - roues multidirectionnelles \varnothing 80 mm.

DE Fahrbarer Mopp Eimer mit Nylonpresse - 2x25 L. Eimer - Wendegriff - Mehrwegräder \varnothing 80 mm.

CA 1604E



IT Secchio carrellato con strizzatore in nylon - 2 secchi da 17 L - maniglione reversibile - ruote multidirezionali da \varnothing 80 mm.

EN Bucket with nylon wringer on wheels - 2x17 L buckets - reversible handle - multidirectional wheels \varnothing 80 mm.

FR Seau sur roue avecessoreuse en nylon - 2 seaux de 17 litres - poignée réversible - roues multidirectionnelles \varnothing 80 mm.

DE Fahrbarer Mopp Eimer mit Nylonpresse - 2x17 L. Eimer - Wendegriff - Mehrwegräder \varnothing 80mm.

	CA 1604
	87 x 42 x 90(h) cm
	215 €

	CA 1604E
	71 x 43 x 93(h) cm
	100 €

Carrelli per pulizia
Cleaning trolleys

CA 1613



IT Carrello per pulizia. Telaio e impugnatura in plastica - secchio, strizzatore e cassette in plastica - strizzatore in plastica a libro senza fondo - portasacco da 100 L completo di rinforzi e coperchio - 2 secchielli da 4 L e 1 secchio da 28 L - gancio portapaletta e gancio portamanico con rullo in gomma.

EN Cleaning trolley Plastic frame and handle - plastic bucket, wringer and trays - plastic wringer without bottom - 100 L bag holder complete with reinforcements and lid - 2x4 L buckets and 1x28 L bucket. - dustpan hook and handle hook with rubber roller.

FR Chariot pour le nettoyage. Corps et poignée en plastique - seau,essoreuse et bacs en plastique -essoreuse en plastique sans fond - porte-sac de 100 L. complet avec renforts et couvercle - 2 seaux de 4 L. et 1 seau de 28 L. - crochet pour palette et manche avec rouleau en caoutchouc.

DE Reinigungswagen. Kunststoffrahmen und -griff - Eimer, Presse und Behälter aus Kunststoff - Kunststoffpresse ohne Boden - 100 L. Sackhalterung komplett mit Verstärkungen und Deckel - 2x4 L. Eimer und 1x28 L. Eimer - Kehrblech- und Griffhaken mit Gummirolle.

CA 1614



IT Carrello per pulizia. Telaio e impugnatura in plastica - secchio, strizzatore e cassetta in plastica media - portasacco - 2 secchielli da 4 L e 1 secchio da 15 L - ganci portascopie - ruote ø 100 mm. Il porta vaschette superiore non è incluso.

EN Cleaning trolley Plastic frame and handle - bucket, wringer and medium plastic tray - bag holder - 2 buckets of 4 L and 1 bucket of 15 L - broom hook - wheels ø 100 mm. The upper tray holder is not included.

FR Chariot pour le nettoyage. Corps et poignée en plastique - seau,essoreuse et bac moyen en plastique moyenne - porte-sac - 2 seaux de 4 L. et 1 seau de 15 L. - crochets porte balai - roues ø 100 mm. Le porte bacs supérieur n'est pas inclus.

DE Reinigungswagen. Kunststoffrahmen und -griff - Eimer, Presse und mittelgroßer Behälter aus Kunststoff - Sackhalterung - 2x4 L. Eimer und 1x15 L. Eimer - Besenhaken - Räder ø 100 mm. Der obere Ablagefachhalter ist nicht inbegriffen.

	CA 1613
	107 x 55 x 111(h) cm
	430 €

	CA 1614
	97 x 68 x 125(h) cm
	530 €

CA 1615



IT Carrello per la pulizia. Telaio e impugnatura in plastica - secchio, strizzatore e cassetta in plastica media - portasacco - 2 secchielli da 4 L e 2 secchi da 15 L - ganci portascopo - ruote \varnothing 100 mm. Portavaschette superiore non incluso.

EN Cleaning trolley Plastic frame and handle - bucket, wringer and medium plastic tray - bag holder - 2x4 L buckets and 2x15 L buckets - broom hook - wheels \varnothing 100 mm. The upper tray holder is not included.

FR Chariot pour le nettoyage. Corps et poignée en plastique - seau, essoreuse et bac moyen en plastique moyenne - porte-sac - 2 seaux de 4 L. et 2 seaux de 15 litres - crochets porte balai - roues \varnothing 100 mm. Le port bacs supérieur n'est pas inclus.

DE Reinigungswagen. Kunststoffrahmen und -griff - Eimer, Presse und mittelgroßer Behälter aus Kunststoff - Sackhalterung - 2x4 L. Eimer und 1x15 L. Eimer - Besenhaken - Räder \varnothing 100 mm. Der obere Ablagefachhalter ist nicht inbegriffen.

	CA 1615
	92 x 68 x 124(h) cm
	550 €

CA 1616



WARNING



IT Carrello per la pulizia. Telaio e impugnatura in plastica - secchio, strizzatore e cassetta in plastica media - cestino portabottiglie portasacco - 4 secchielli da 4 L e 2 secchi da 15 L - ganci portascopo - vano centrale con cassetto scorrevole - ruote \varnothing 100 mm. Coperchio superiore di colore blu non incluso nel prezzo.

EN Cleaning trolley Plastic frame and handle - bucket, wringer and medium plastic tray - bottle rack - bag holder - 2x4 L buckets and 2x15 L buckets - broom hook - central compartment with sliding drawer - wheels \varnothing 100 mm. Blue lid not included in the price.

FR Chariot pour le nettoyage. Corps et poignée en plastique - seau, essoreuse et bac moyen en plastique moyenne - corbeille pour bouteilles, porte-sac - 4 seaux de 4 L. et 2 seaux de 15 litres - crochets porte balai - compartiment central avec tiroir coulissant - roues \varnothing 100 mm. Couvercle supérieur bleu non compris dans le prix.

DE Reinigungswagen. Kunststoffrahmen und -griff - Eimer, Presse und mittelgroßer Behälter aus Kunststoff - Flaschenkorb und Sackhalterung - 2x4 L. Eimer und 1x15 L. Eimer - Besenhaken - Mittelfach mit Schiebeschublade - Räder \varnothing 100 mm. Blaue obere Abdeckung nicht im Preis inbegriffen.

	CA 1616
	133 x 68 x 124(h) cm
	840 €

Carrelli per pulizia
Cleaning trolleys



Foto con OPTIONAL: coperchio superiore non incluso
Photos with OPTIONAL: lid not included
Photo avec ACCESSOIRES: couvercle supérieur non compris
Abgebildet mit ZUBEHÖR: Obere Abdeckung nicht im Preis inbegriffen.

CA 1606E



CA 1520



IT Carrello per pulizia. Telaio e impugnatura in plastica - secchio con strizzatore in plastica - portasacco con sacco da 120 L - attacco porta utensili.

IT Carrello multiuso in plastica.

EN Cleaning trolley Plastic frame and handle - bucket with plastic wringer - bag holder with 120 L bag - tool holder.

EN Multi-purpose plastic trolley.

FR Chariot pour le nettoyage. Corps et poignée en plastique - seau avecessoreuse en plastique - porte-sac avec sac de 120 L. - porte-outils.

FR Chariot en plastique polyvalent.

DE Reinigungswagen. Kunststoffrahmen und -griff - Eimer mit Kunststoffpresse - Sackhalterung mit 120 L. Sack - Werkzeughalteranschluss.

DE Mehrzweckwagen aus Kunststoff.

	CA 1606E
	114 x 51 x 98(h) cm
	230 €

	CA 1520
	150 x 54 x 99(h) cm
	325 €

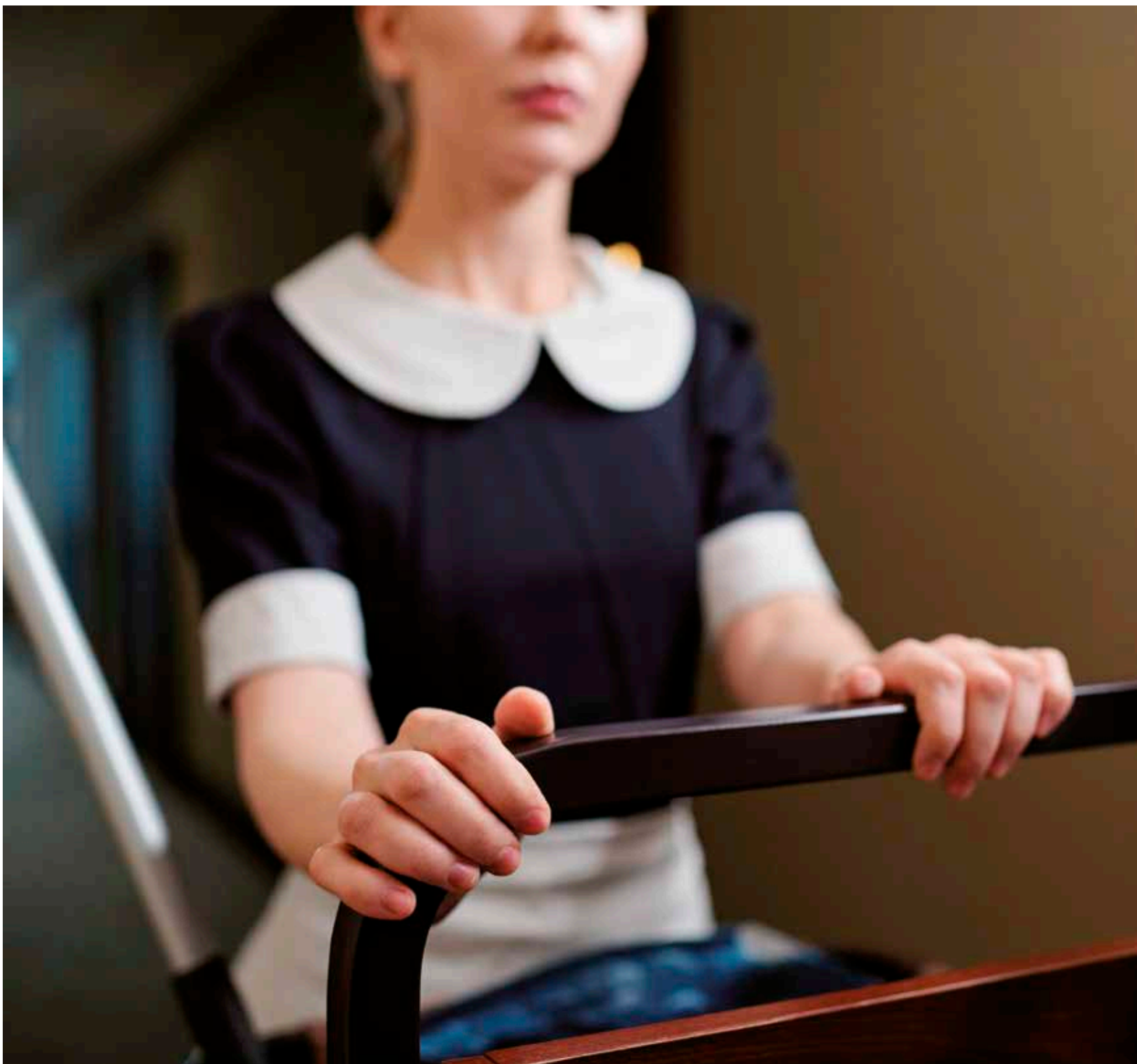



Articoli vari per la macelleria

ITEMS FOR THE MEAT PROCESSING
ARTICLES POUR
LA TRANSFORMATION DE LA VIANDE
ARTIKEL FÜR DIE FLEISCHVERARBEITUNG

LMMC



- IT Combinato lavamani più lavastracci in acciaio inox con rubinetto acqua calda/fredda.
- EN Stainless steel combi hand washer and rags washer with hot / cold water tap.
- FR Lave-mains combiné en acier inox avec robinet d'eau chaude / froide.
- DE Handwasch- & Ausgussbecken übereinanderliegend mit Heiß / Kaltwassermischer.

LMM



- IT Lavamani con mobile e comandi a ginocchio. Lavamani in acciaio inox su mobile con porte a battente - comando a ginocchio.
- EN Hand washer on neutral element with knee lever. Stainless steel hand washer on cabinet with hinged doors - knee lever.
- FR Lave-mains sur meuble neutre avec commande à genou. Lave-mains en acier inox sur meuble à portes battantes - commande à genou.
- DE Handwaschbecken auf Schrank mit Kniehebel. Handwaschbecken auf Schrank mit Flügeltüren - Kniehebel.

LM 48M



	LMMC
	70 x 50 x 89(h) cm
	745 €

	LMM	LM 48M
	50 x 40 x 85(h) cm	40 x 40 x 85(h) cm
	570 €	550 €

Lavamani
Hand washer

LC 50MM



LM 40



LM 48



LC 50



IT Lavamani e lavautensili con mobile. Lavamani e utensili su mobile in acciaio inox - porta battente - miscelatore acqua calda/fredda vasca da 40x40x25(h) cm.

EN Hand washer and tools washer on cabinet. Hand washer and tools washer on stainless steel cabinet - hinged door - hot / cold water tap, bowl 40x40x25(h) cm.

FR Lave-mains et lave-outils sur meuble. Lave-mains et lave-outils sur meuble en acier inox - porte battante - robinet d'eau chaude / froide cuve 40x40x25(h) cm.

DE Hand- und Werkzeugwaschbecken auf Schrank. Hand- und Werkzeugwaschbecken auf Edelstahlschrank - Flügeltür - 40x40x25(h) cm Heiß-/Kaltwassermischer.

IT Lavamani a colonna e comandi a ginocchio. Struttura in acciaio inox.

EN Pillar hand washer with knee lever. Stainless steel structure.

FR Colonne lave-mains avec commandes à genou. Structure en acier inox.

DE Säulenhandwaschbecken mit Kniehebel. Edelstahlstruktur.

	LC 50MM
	50 x 50 x 85(h) cm
	745 €

	LM 40	LM 48	LC 50
	40 x 40 x 28(h) cm	48 x 35 x 53(h) cm	50 x 40 x 80(h) cm
	275 €	375 €	390 €

SUVN



IT Armadietto sterilizzatore universale a raggi UV costruito in acciaio inox con finitura Scotch Brite. Adatto per utensilerie varie - funzionamento con lampada germicida con griglia di protezione - portina in plexiglas trasparente con microinterruttore - temporizzatore 60' e lampada spia di funzionamento - cavo con spina. Disponibili ad uno o due scomparti.



EN Universal UV steriliser cabinet made of stainless steel with Scotch Brite finish. Ideal for various tools - germicidal lamp operation with protection grid - clear Plexiglas door with microswitch - 60' timer and indicator lamp - cable with plug. Available with one or two compartments.

FR Armoire stérilisateur UV universelle en acier inox avec finition Scotch Brite. Indiqué pour divers ustensiles - fonctionnement avec lampe germicide avec grille de protection - porte en plexiglas transparent avec microinterruteur - minuteur 60' et indicateur lumineux de fonctionnement - câble avec fiche. Disponible avec une ou deux compartiment.

DE UV-Sterilisationsschrank aus Scotch Brite Edelstahl. Geeignet für verschiedene Utensilien - Funktionsweise mit keimtötender Lampe mit Schutzgitter - klare Plexiglastür mit Mikroschalter - 60'-Timer und Anzeigelampe - Kabel mit Stecker. Erhältlich mit einem oder zwei Einlegeböden.

SUVN2P



	SUVN	SUVN2P
	16 W	16 x 2 W
 1 Ph	220-240V/1N/50-60 Hz	
	51 x 28 x 35(h) cm	51 x 28 x 70(h) cm
	450 €	800 €

Sterilizzatori
Sterilizers

SUV 10

SUV 14

SN 38



IT Armadietto sterilizzatore a raggi UV costruito in acciaio inox AISI 304 Scotch Brite. Portina in plexiglas trasparente con microinterruttore - portacoltelli in acciaio inox - funzionamento con lampada germicida con griglia di protezione temporizzatore 60' e lampada spia di funzionamento - cavo con spina.

EN UV sterilizer cabinet made of Scotch Brite stainless steel AISI 304. Clear Plexiglas door with microswitch - stainless steel knife holder - operation with germicidal lamp with 60' timer protection grid and indicator lamp - cable with plug.

FR Armoire stérilisateur UV en acier inox Scotch Brite AISI 304. Porte en plexiglas transparent avec microinterrupteur - porte-couteau en acier inox - fonctionnement avec lampe germicide avec grille de protection, minuteur 60' et indicateur lumineux - câble avec fiche.





DE UV-Sterilisationsschrank aus Scotch Brite Edelstahl AISI 304. Tür aus klarem Plexiglas mit Mikroschalter - Messerhalter aus Edelstahl - Betrieb mit Keimtöterlampe mit 60' Timer, Schutzgitter und Anzeigelampe - Kabel mit Stecker.





IT Sterilizzatore elettrico per coltelli. Struttura in acciaio inox - termostato regolabile interno +30 +110°C - rubinetto di carico e scarico.

EN Electric knives sterilizer Stainless steel structure - internal adjustable thermostat +30 +110°C - filling and emptying tap.

FR Stérilisateur électrique pour couteaux. Structure en acier inox - thermostat interne réglable +30 +110°C - robinet de remplissage et de vidange.

DE Elektrische Sterilisatoren für Messer. Edelstahlstruktur - innenliegender einstellbarer Thermostat +30 +110°C - Be- und Entladehahn.

	SUV 10	SUV 14
	16 W	
 1 Ph	220-240V/1N/50-60 Hz	
	N° 10 coltelli - knives	N° 14 coltelli - knives
 cm	43 x 16 x 64(h) cm	54 x 16 x 64(h) cm
	330 €	345 €

	SN 38
	1500 W
 1 Ph	220-240V/1N/50-60 Hz
	N° 12 coltelli - knives
 cm	38 x 14 x 40(h) cm
	385 €

CCL

IT Ceppo in legno di acacia e sgabello. Ceppo trattato con vernice atossica e collanti ecologici (conformi alle norme vigenti) assemblato con innesti a pressione e internamente con inserti speciali in legno - batticarne ecologico e riciclabile - reversibile.

EN Acacia wood chopping block and stool. Chopping block treated with non-toxic paint and ecological adhesives (in compliance with current standards) assembled with pressure joints and internally with special wood inserts - ecological and recyclable meat beater - reversible.

FR Blocs de boucher en bois d'acacia et tabouret. Bloc traité avec peinture atoxique et adhésifs écologiques (conformes aux normes en vigueur) assemblés avec embrayages à pression et intérieur avec inserts spéciaux en bois - bloc à viande écologique et recyclable - réversible.

DE Metzger-Block aus Akazienholz und Hocker. Metzger-Block behandelt mit ungiftiger Farbe und ökologischen Klebstoffen (nach den gültigen Normen), zusammengebaut mit Steckverbindungen und speziellen innen Holzeinsätzen - umweltfreundlicher und wiederverwertbarer Fleischklopper - beidseitig.



	CCL 1744	CCL 1745	CCL 1755	CCL 1764	CCL 1766	CCL 1774	CCL 1775
	40 x 40 x 90(h) cm	45 x 45 x 90(h) cm	50 x 50 x 90(h) cm	60 x 40 x 90(h) cm	60 x 60 x 90(h) cm	70 x 40 x 90(h) cm	70 x 50 x 90(h) cm
	590 €	655 €	765 €	765 €	1.020 €	850 €	1.020 €



SPESSORE / THICKNESS 17 cm

	CCL 2544	CCL 2555	CCL 2564	CCL 2566	CCL 2574	CCL 2575	CCL 2577
	40 x 40 x 90(h) cm	50 x 50 x 90(h) cm	60 x 40 x 90(h) cm	60 x 60 x 90(h) cm	70 x 40 x 90(h) cm	70 x 50 x 90(h) cm	70 x 70 x 90(h) cm
	740 €	950 €	950 €	1.170 €	1.010 €	1.170 €	1.390 €



SPESSORE / THICKNESS 25 cm

	CCL 3555	CCL 3566	CCL 3575	CCL 3577	CCL 3586
	50 x 50 x 90(h) cm	60 x 60 x 90(h) cm	70 x 50 x 90(h) cm	70 x 70 x 90(h) cm	80 x 60 x 90(h) cm
	1.170 €	1.455 €	1.455 €	1.805 €	1.805 €



SPESSORE / THICKNESS 35 cm

Ceppi
Butcher blocks

CCP

IT Ceppo in polietilene e sgabello in acciaio inox **AISI 304**.

EN Polyethylene block and **AISI 304** stainless steel stool.

FR Bloc en polyéthylène et tabouret en acier inox **AISI 304**.

DE Polyethylenblock und Hocker aus Edelstahl **AISI 304**.



	CCP 8000	CCP 8001	CCP 8002	CCP 8003
	40 x 40 x 88(h) cm	50 x 50 x 88(h) cm	70 x 50 x 88(h) cm	60 x 60 x 88(h) cm
	420 €	490 €	590 €	610 €

	CCP 8004	CCP 8005	CCP 8006
	70 x 70 x 88(h) cm	80 x 60 x 88(h) cm	100 x 50 x 88(h) cm
	720 €	710 €	710 €

KCP

IT Copriceppo di polietilene bianco.

EN White polyethylene block cover.

FR Couverture en polyéthylène blanc.

DE Weiße Polyethylenabdeckung.



	KCP 2501	KCP 2502	KCP 2503	KCP 2504
	40 x 40 x 1,5(h) cm	50 x 50 x 1,5(h) cm	60 x 40 x 1,5(h) cm	60 x 60 x 1,5(h) cm
	50 €	70 €	65 €	80 €

	KCP 2505	KCP 2506	KCP 2508
	70 x 40 x 1,5(h) cm	70 x 50 x 1,5(h) cm	70 x 70 x 1,5(h) cm
	75 €	80 €	100 €

CPE

IT Ceppo di polietilene alimentare bianco.

EN Chopping block made of white food grade polyethylene.

FR Bloc en polyéthylène alimentaire.

DE Polyethylenblock.



	CPE 40408	CPE 50508	CPE 70508	CPE 60608
	40 x 40 x 8(h) cm	50 x 50 x 8(h) cm	70 x 50 x 8(h) cm	60 x 60 x 8(h) cm
	170 €	245 €	320 €	350 €

	CPE 70708	CPE 80608	CPE 100508
	70 x 70 x 8(h) cm	80 x 60 x 8(h) cm	100 x 50 x 8(h) cm
	455 €	445 €	445 €

TP



IT Taglieri in polietilene.

EN Polyethylene cutting boards.

FR Planches à découper en polyéthylène.

DE Schneidebretter aus Polyethylen.



	TP 40302 bianco-white	TP 50402 bianco-white	TP 70402 bianco-white	TP 80402 bianco-white
	40 x 30 x 2(h) cm	50 x 40 x 2(h) cm	70 x 40 x 2(h) cm	80 x 40 x 2(h) cm
	30 €	47 €	65 €	75 €

Per scelta colore aggiungere al codice:
For colour choice add to code:
Pour choisir la couleur, ajoutez au code:
Fügen Sie für die Farbauswahl den Code hinzu:



	TP 50302 bianco-white	TP 60402 bianco-white
	50 x 30 x 2(h) cm Y/M/G/B/R	60 x 40 x 2(h) cm Y/M/G/B/R
	36 €	56 €

Y = Giallo / Yellow / Gelb / Jaune
M = Marrone / Brown / Braun / Marron
G = Verde / Green / Grün / Vert
B = Blu / Blue / Blau / Bleu
R = Rosso / Red / Rot / Rouge

RASK

IT **RASK:** Raschietto per pulizia ceppi e taglieri
compreso di 4 lamette.

EN **RASK:** Scraper for butcher blocks
and cutting boards cleaning.

FR **RASK:** Racloir pour le nettoyage des blocs
et des planches à découper.

DE **RASK:** Schaber zum Reinigen von Metzger-Blöcke
und Schneidebrettern.



	RASK
	45 €

Taglieri e raschietto
Cutting boards and scraper

ANTINFORTUNISTICA PER MACELLERIA

EN Accident prevention
for butchers.

FR Prévention des accidents
pour les bouchers.

DE Unfallverhütung für Metzger.



	AV 4898
1	Grembiule acciaio inox antinfortunistico con bretelle Stainless steel safety apron with shoulder straps Tablier de sécurité en acier inox avec sangles d'épaule Edelstahl-Sicherheitschürze mit Schultergurten
	210 €

	AV 4900
2	Guanto inox antinfortunistico a cinque dita con cinturino inox completamente sterilizzabile Five-finger stainless steel safety glove with stainless steel strap, fully sterilisable Gant de sécurité à cinq doigts en acier inox avec sangle en acier inox, entièrement stérilisable Edelstahl-Fünf-Finger-Sicherheitshandschuh mit Edelstahlband völlig sterilisierbar
	170 €

	AV 4901
3	Guanto inox antinfortunistico a cinque dita con chiusura a molla inox. Avambraccio compreso Stainless steel five finger safety glove with stainless steel spring fastening. Forearm included. Gant de sécurité à cinq doigts en acier inox avec fermeture à ressort en acier inox. Avant-bras inclus. Edelstahl-Fünf-Finger-Sicherheitshandschuh mit Edelstahl-Feder-Verschluss. Unterarm inklusive.
	300 €

Grembiuli e guanti
Aprons and gloves

Scaffalatura modulare

Modular shelving



IT Scaffalatura modulare in alluminio anodizzato. Design rispondente alle norme igieniche con superfici lisce ed arrotondate, profili chiusi e totale assenza di spazi o fessure - leghe di alta qualità resistenti all'usura prodotta da agenti chimici, termici e meccanici - ampia scelta di misure - possibilità di inserimento vaschette serie Gastronorm GN1/2-GN1/1-GN2/1-GN2/3 inserite all'interno dei ripiani.

EN Modular shelving in anodized aluminium. Design in compliance with hygiene standards with smooth and rounded surfaces, closed profiles and total absence of spaces or gaps - high quality alloys resistant to wear produced by chemical, thermal and mechanical agents - wide choice of sizes - possibility of inserting Gastronorm containers GN1/2-GN1/1-GN2/1-GN2/3 inside the shelves.

FR Rayonnage modulaire en aluminium anodisé. Design hygiénique avec des surfaces lisses et arrondies, des profilés fermés et absence totale d'espaces ou de fissures - alliages de haute qualité résistants à l'usure par des agents chimiques, thermiques et mécaniques - large choix de dimensions - possibilité d'insérer des bacs Gastronorm GN1/2-GN1/1-GN2/1-GN2/1-GN2/3 dans les étagères.

DE Modulare Regale aus eloxiertem Aluminium. Design nach Hygienestandards mit glatten und abgerundeten Oberflächen, geschlossenen Profilen und völliger Abwesenheit von Zwischenräumen oder Rissen - hochwertige, verschleißfeste Legierungen gegen chemischen, thermischen und mechanischen Werkstoffen - umfangreiche Größenauswahl - Behältern der Serie Gastronorm GN1/2-GN1/1-GN2/1-GN2/1-GN2/3, in den Regalen einsetzbar.

IT Ripiani in alluminio completi di griglie in polietilene. Composti da: 2 fiancate, 4 attacchi, serie griglie.

EN Aluminium shelves complete with polyethylene grids. Composed of: 2 sides, 4 brackets, grids.

FR Étagères en aluminium complètes avec des grilles en polyéthylène. Composé de: 2 côtés, 4 supports, série de grilles.

DE Aluminiumzwischenetagen komplett mit Polyethylen-Gittern. Bestehend aus: 2 Seitenpaneele, 4 Halterungen, Gittern.

i	R62	R88	R97	R106
	Max. 240 kg	Max. 180 kg	Max. 170 kg	Max. 150 kg
↗ cm	37,3 x 62 cm	37,3 x 88,6 cm	37,3 x 97,4 cm	37,3 x 106,2 cm
	60 €	70 €	75 €	80 €

i	R115	R124	R133	R150
	Max. 140 kg	Max. 130 kg	Max. 110 kg	Max. 90 kg
↗ cm	37,3 x 115,2 cm	37,3 x 124 cm	37,3 x 133 cm	37,3 x 150,5 cm
	86 €	86 €	98 €	105 €

IT Testata in alluminio completa di: 2 piantane, 3 traversini, 2 piedi e 2 tappi.

EN Stainless steel front panel. Complete with: 2 pillars, 3 crosspieces, 2 feet and 2 plugs.

FR Façade en aluminium. Complète avec: 2 montants, 3 traverses, 2 pieds et 2 capuchons.

DE Edelstahlfrontblende. Komplett mit: 2 Träger, 3 Querstäbe, 2 Füße und 2 Kappen.

i	F15	F17	F20
↗ cm	37,3 x 155(h) cm	37,3 x 170(h) cm	37,3 x 200(h) cm
	98 €	98 €	108 €

i	GA373
↗ cm	37,3 cm
	25 €

IT Giunzioni per angolo.

EN Corner joints.

FR Joints de coin.

DE Eckverbindungen.

FT30

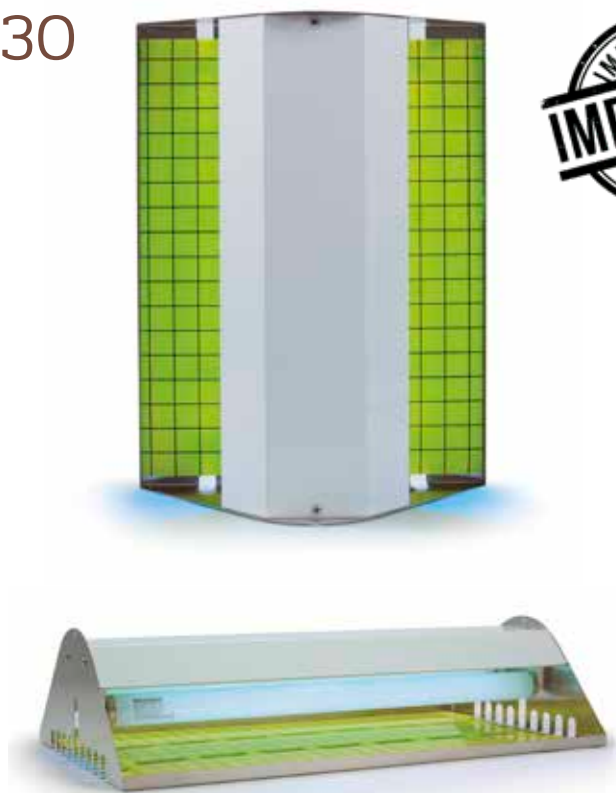

PZ30N

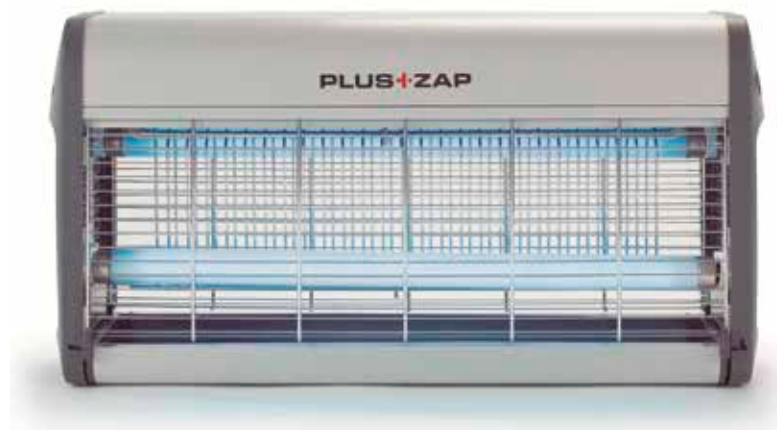

IT Elettroinsetticidi a lampade UVA. Materiale: FT30 acciaio inox AISI 304; PZ30N alluminio. Potenza 30W. Lampade 2x15W - possibilità di montaggio in orizzontale o verticale - copertura fino a 80 mq.

EN Electro-insecticides with UVA lamps. Material: FT30 AISI 304 stainless steel - Aluminium PZ30N. Power 30W. 2x15W lamps - horizontal or vertical installation - surface cover up to 80 sqm.

FR Electro-insecticides avec lampes UVA. Matériel: FT30 acier inox AISI 304; aluminium PZ30N. Puissance 30W. 2 Lampes 15W - possibilité de montage horizontal ou vertical - portée jusqu'à 80 m².

DE Elektroinsekt-Killer mit UVA-Lampen. Material: FT30 Edelstahl AISI 304; Aluminium PZ30N. Leistung 30W. 2x15W Lampen - horizontale oder vertikale Montage möglich - Reichweite bis zu 80 qm.

	FT30	PZ30N
	48 x 36 x 16(h) cm	55 x 11 x 26(h) cm
	260 €	130 €

Optional

CR30
FT30

Collante di ricambio confezione da 6 pezzi
Spare glue pack of 6 pieces
Colle de rechange 6 pièces
Ersatzkleber 6 Stück-Packung

54 €

L617
PZ30N - FT30

Lampada da 15 W
15 W lamp
Lampe 15 W
15 W Lampe

12 €

Elettroinsetticidi
Electro-insecticides



Attrezzatura per la colazione

BREAKFAST EQUIPMENT
ÉQUIPEMENT DE PETIT-DÉJEUNER
FRÜHSTÜCKSAUSRÜSTUNG

CD 7905

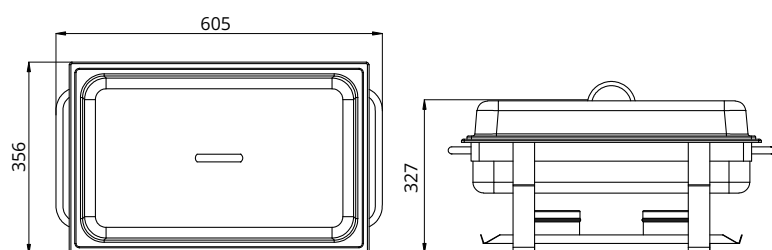

IT Chafing dish con coperchio. Struttura rettangolare in acciaio inox - bruciatori ad alcool.

EN Chafing dish with lid. Rectangular stainless steel casing - alcohol burners.

FR Chafing Dish avec couvercle. Corps rectangulaire en acier inox - Brûleurs à alcool.

DE Chafing Dish mit Deckel. Rechteckige Edelstahlstruktur - Alkohol-Brenner.

	CD 7905
	60,5 x 35,6 x 32,7(h) cm - 8,5 L
	115 €

CD 9801

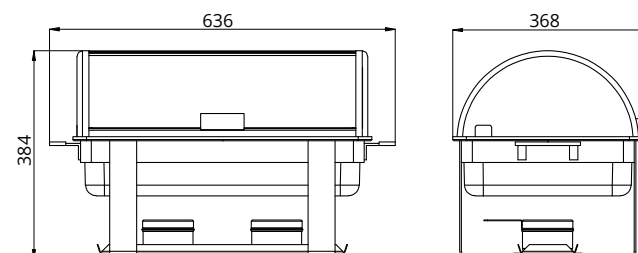

IT Chafing dish con coperchio roll top. Struttura in acciaio inox lucido - bruciatori ad alcool.

EN Chafing dish with roll top lid. Rectangular polished stainless steel casing - alcohol burners.

FR Chafing Dish avec couvercle supérieur roll top. Corps rectangulaire en acier inox poli - Brûleurs à alcool.

DE Chafing Dish mit Roll-Top Deckel. Rechteckige polierte Edelstahlstruktur - Alkohol-Brenner.

	CD 9801
	63,6 x 36,8 x 38,4(h) cm - 8,5 L
	260 €

Chafing dishes

CD 6502



CD 6504

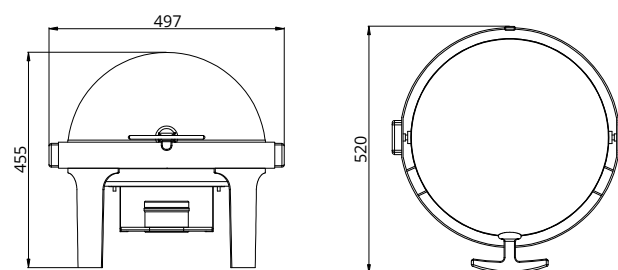
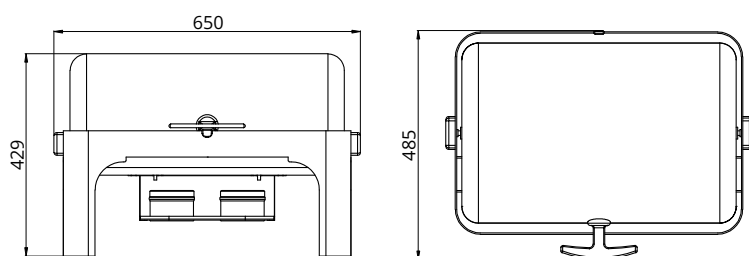

IT Chafing dish con coperchio roll top 180°. Struttura in acciaio inox lucido - bruciatori ad alcool.

EN Chafing dish with roll top lid 180°. Rectangular polished stainless steel casing - alcohol burners.

FR Chafing Dish avec couvercle supérieur roll top 180°. Corps rectangulaire en acier inox poli - Brûleurs à alcool.

DE Chafing Dish mit 180° Roll-Top Deckel. Rechteckige polierte Edelstahlstruktur - Alkohol-Brenner.

IT Chafing dish tondo con coperchio roll top 180°. Struttura in acciaio inox lucido - bruciatori ad alcool.

EN Round Chafing dish with roll top lid 180°. Rectangular polished stainless steel casing - alcohol burners.

FR Chafing Dish ronde avec couvercle supérieur roll top 180°. Corps rectangulaire en acier inox poli - Brûleurs à alcool.

DE Rundes Chafing Dish mit 180° Roll-Top Deckel. Rechteckige polierte Edelstahlstruktur - Alkohol-Brenner.

	CD 6502
	65 x 48,5 x 42,9 (h) cm - 8,5 L
	480 €

	CD 6504
	49,7 x 52 x 45,5 (h) cm - 6 L
	445 €

CD 6505

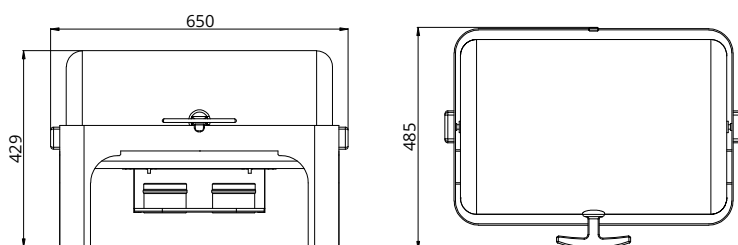

- IT** Chafing dish con coperchio roll top 180° e pentole da 4,6 L Struttura in acciaio inox lucido - bruciatori ad alcool.
- EN** Chafing dish with roll top lid 180° and 4,6 L pans. Rectangular polished stainless steel casing - alcohol burners.
- FR** Chafing Dish avec couvercle supérieur roll top 180° t marmites de 4,6 L. Corps rectangulaire en acier inox poli - Brûleurs à alcool.
- DE** Chafing Dish mit 180° Roll-Top Deckel und 4,6 L. Töpfe. Rechteckige polierte Edelstahlstruktur - Alkohol-Brenner.

	CD 6505
	65 x 48,5 x 42,9 (h) cm
	580 €

Chafing dishes

Optional

	AV9516 CD 7905 - CD 9801 - CD 6502 - CD 6504 - CD 6505
	360 W
 1 Ph	220-240V/1N/50-60 Hz
	Elemento di riscaldamento elettrico per Chafing Dishes Electric heating element for Chafing Dishes Élément électrique de chauffage pour Chafing Dishes Elektrischer Heizelement für Chafing Dishes
	110 €

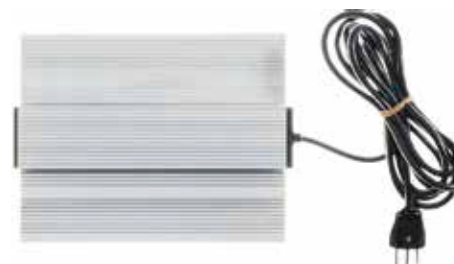

B 8001



DC 10502



AV9517 - 180 W
DC10502

Elemento elettrico riscaldante
Electric heating element
Élément électrique chauffant
Elektrischer Heizelement

100 €



IT Zuppiera elettrica. Corpo in alluminio verniciato - contenitore e coperchio in acciaio inox.

EN Electric soup tureen. Painted aluminium casing - stainless steel container and lid.

FR Soupière électrique. Corps en aluminium peint - récipient et couvercle en acier inox.

DE Elektrische Terrine. Gehäuse aus lackiertem Aluminium - Behälter und Deckel aus Edelstahl.

IT Distributore caldo per caffè. Struttura in acciaio inox - bruciatore ad alcool.

EN Hot coffee dispenser. Stainless steel casing - alcohol burner.

FR Distributeur de café chaud. Corps en acier inox poli - Brûleurs à alcool.

DE Heißkaffeenspender. Gehäuse aus Edelstahl - Alkohol-Brenner.

	B 8001
	220-240V/1N/50 Hz 360 W
	ø 35 x 36(h) cm
	10 L
	245 €

	DC 10502
	33 x 24 x 54(h) cm
	9 L
	305 €

Zuppiera elettrica
Electric soup tureen

Distributori caffè, bevande e cereali
Coffee, drinks and cereals dispensers

DCN 1706



DS 10401



DS 10402



IT Distributore caldo per caffè. Struttura in ABS con copertura in acciaio inox - dotato di termica di sicurezza - temperatura 90°C.

EN Hot coffee dispenser. ABS structure with stainless steel cover - equipped with safety thermic - temperature 90°C.

FR Distributeur de café chaud. Corps en ABS avec couvercle en acier inox - équipée d'un thermique de sécurité - température 90°C.

DE Heißkaffeenspender. ABS-Gehäuse mit Edelstahlabdeckung - ausgestattet mit Sicherheitsthermik - Temperatur 90°C

IT Distributore bevande. Contenitore trasparente - tubo centrale per contenimento ghiaccio.

EN Beverage dispenser. Clear container - central tube for ice filling.

FR Distributeur de boissons. Récipient transparent - tube central pour contenir de la glace.

DE Getränkespender. Klarer Behälter - Zentralrohr für die Eiseinführung.

	DCN 1706
	110 W
	220-240V/1N/50 Hz
	ø 29 x 44(h) cm
	7 L (40 tazzine - cup)
	275 €

	DS 10401	DS 10402
	27 x 22 x 58(h) cm	32 x 32 x 58(h) cm
	8 L	5 + 5 L
	245 €	490 €

DC 10301 - DC 10302



- IT Distributore per cereali. Contenitori trasparenti, singoli o doppi.
- EN Cereals dispenser. Clear containers, single or double.
- FR Distributeur de céréales. Récipients transparents, simples ou doubles.
- DE Müslispender. Transparente Behälter, einfach oder doppelt.

	DC 10301	DC 10302
	36 x 26 x 66(h) cm	48 x 26 x 66(h) cm
	8 L	8 + 8 L
	190 €	430 €

AV 4561

- IT Fornello flambé a gas in rame con griglia in acciaio inox.
- EN Copper gas flambé cooker with stainless steel grid.
- FR Cuisinière flambée à gaz en cuivre avec grille en acier inox.
- DE Flambé Gasherd aus Kupfer mit Edeltstahlgitter.



	AV 4561
	ø 26 x 29,5(h) cm
	470 €

Fornello Flambè Flambè cooker

AV 4580 - AV 4581

- IT Padella flambè inox-cuprum, manico legno.
- EN Flambé pan stainless steel-cuprum, wooden handle.
- FR Poêle flambée en acier inox-cuprum, manche en bois.
- DE Flambé Cuprum-Pfanne aus Edelstahl mit Holzgriff.



	AV 4580	AV 4581
	ø 29 cm	ø 26 cm
	185 €	140 €

Padella Flambè Flambé pan

T906







IT Bollitore elettrico in acciaio inox - spegnimento automatico al raggiungimento dell'ebollizione - due livelli di potenza - capacità contenitore 1,7 L - livello acqua visibile - base in plastica.

EN Stainless steel electric kettle - automatically switches off when boiling temperature is reached - two power levels - 1,7 L container - visible water level - plastic base.

FR Bouilloire électrique en acier inox. Arrêt automatique une fois la température d'ébullition atteinte - deux niveaux de puissance - capacité du récipient 1,7 L - niveau d'eau visible - base en plastique.

DE Elektrischer Wasserkocher aus Edelstahl - automatische Abschaltung beim Kochen - zwei Leistungsstufen - 1,7 L Behälterinhalt. - sichtbarer Wasserstand - Kunststoffsockel.

	T906
	1850 - 2200 W
 1 Ph	220-240V/1N/50-60Hz
	1.7 L
 mm	15 x 22 x 23(h) cm
	60 €

Bollitore elettrico
Electric kettle



Z3035







IT Coltello elettrico con corpo in abs e lama in acciaio inox.

EN Electric knife with abs casing and stainless steel blade.

FR Couteau électrique avec corps en ABS et lame en acier inox.

DE Elektrisches Messer mit Kunststoffgehäuse und Klinge aus Edelstahl.

	Z3035
	180 W
 1 Ph	220-240V/1N/50Hz
 RPM	3000 rpm
 mm	47 x 14 x 7(h) cm
	45 €





Coltello elettrico
Electric knife



Articoli vari



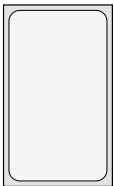
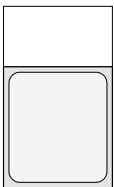

per cucina e pizzeria

ITEMS FOR COOKING AND PIZZERIA
ARTICLES POUR LA CUISINE
ET POUR LA PIZZERIA
KÜCHE- UND PIZZERIA-ARTIKEL



BACINELLE - CONTAINERS BASSINES - BEHÄLTER					
MOD. 2/1 Est. 646 x 530 mm Int. 620 x 500 mm 	GNI 21200	20(h) cm	60 L	142 €	
	GNI 21150	15(h) cm	44,9 L	116 €	
	GNI 21100	10(h) cm	31,5 L	86 €	
	GNI 2165	6,5(h) cm	18,9 L	63 €	
	GNI 2140	4(h) cm	12 L	60 €	
	GNI 2120	2(h) cm	6,5 L	57 €	
	GRI 21	Griglia - Grill		59 €	
MOD. 1/1 Est. 530 x 325 mm Int. 500 x 300 mm 	GNI 11200	20(h) cm	30 L	75 €	
	GNI 11150	15(h) cm	20,6 L	64 €	
	GNI 11100	10(h) cm	13,3 L	45 €	
	GNI 1165	6,5(h) cm	8,5 L	34 €	
	GNI 1140	4(h) cm	5,5 L	29 €	
	GNI 1120	2(h) cm	2,5 L	25 €	
	COPI 11	Coperchio Lid		27 €	
	COPG 11	Coperchio a tenuta Leak-proof lid		72 €	
	FFF 11	Falso fondo forato Perforated false bottom		27 €	
	GRI 11	Griglia - Grill		37 €	
	S 530	Separatore Divider		8 €	
MOD. 2/3 Est. 352 x 325 mm Int. 329 x 300 mm 	GNI 23200	20(h) cm	19,3 L	62 €	
	GNI 23150	15(h) cm	13,6 L	52 €	
	GNI 23100	10(h) cm	8,9 L	34 €	
	GNI 2365	6,5(h) cm	5,5 L	24 €	
	GNI 2340	4(h) cm	3,5 L	23 €	
	GNI 2320	2(h) cm	1,8 L	18 €	
	COPI 23	Coperchio Lid		18 €	
	COPG 23	Coperchio a tenuta Leak-proof lid		54 €	
	FFF 23	Falso fondo forato Perforated false bottom		22 €	
	GRI 23	Griglia - Grill		25 €	

ACCIAIO INOX AISI 304 S/STEEL AISI 304

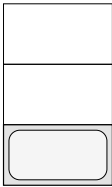
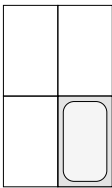

BACINELLE - CONTAINERS BASSINES - BEHÄLTER					
MOD. 1/2 Est. 325 x 265 mm Int. 300 x 238 mm 	GNI 12200	20(h) cm	11,6 L	41 €	
	GNI 12150	15(h) cm	9,9 L	38 €	
	GNI 12100	10(h) cm	8 L	27 €	
	GNI 1265	6,5(h) cm	4,2 L	20 €	
	GNI 1240	4(h) cm	2,5 L	18 €	
	GNI 1220	2(h) cm	1,2 L	15 €	
	COPI 12	Coperchio Lid		15 €	
	COPG 12	Coperchio a tenuta Leak-proof lid		47 €	
	FFF 12	Falso fondo forato Perforated false bottom		15 €	
	S 325	Separatore Divider		6 €	
MOD. 1/3 Est. 325 x 176 mm Int. 300 x 150 mm 	GNI 13200	20(h) cm	8,1 L	40 €	
	GNI 13150	15(h) cm	5,9 L	30 €	
	GNI 13100	10(h) cm	3,8 L	18 €	
	GNI 1365	6,5(h) cm	2,5 L	16 €	
	GNI 1340	4(h) cm	1,5 L	14 €	
	GNI 1320	2(h) cm	0,7 L	10 €	
	COPI 13	Coperchio Lid		11 €	
	COPG 13	Coperchio a tenuta Leak-proof lid		42 €	
FFF 13	Falso fondo forato Perforated false bottom		12 €		
MOD. 1/4 Est. 265 x 162 mm INT. 238 x 136 mm 	GNI 14200	20(h) cm	4,9 L	33 €	
	GNI 14150	15(h) cm	4,1 L	22 €	
	GNI 14100	10(h) cm	2,5 L	18 €	
	GNI 1465	6,5(h) cm	1,9 L	15 €	
	GNI 1440	4(h) cm	1 L	14 €	
	GNI 1420	2(h) cm	0,5 L	11 €	
	COPI 14	Coperchio Lid		9 €	
	COPG 14	Coperchio a tenuta Leak-proof lid		37 €	
	S 265	Separatore Divider		6 €	

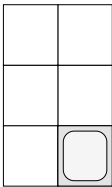
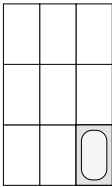

BACINELLE - CONTAINERS BASSINES - BEHÄLTER					
MOD. 1/6 Est. 176 x 162 mm Int. 140 x 153 mm 	GNI 16200	20(h) cm	3 L	35 €	
	GNI 16150	15(h) cm	2,5 L	21 €	
	GNI 16100	10(h) cm	1,6 L	17 €	
	GNI 1665	6,5(h) cm	1,1 L	14 €	
	COPI 16	Coperchio Lid		8 €	
	COPG 16	Coperchio a tenuta Leak-proof lid		27 €	
MOD. 1/9 Est. 176 x 108 mm Int. 140 x 100 mm 	GNI 19100	10(h) cm	0,9 L	16 €	
	GNI 1965	6,5(h) cm	0,5 L	13 €	
	COPI 19	Coperchio Lid		7 €	









ATTENZIONE i coperchi a tenuta possono essere applicati solo su bacinelle GN con H mm. 100, 150 e 200

ATTENTION the leak-proof lids can only be applied to GN basins with H 100, 150 and 200 mm.





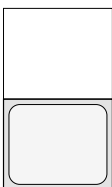

ATTENTION les couvercles anti-fuite ne peuvent être appliqués que sur des bassines GN avec H 100, 150 et 200 mm.





ACHTUNG Die versiegelten Deckel können nur bei GN-Behältern mit H 100, 150 und 200mm eingesetzt werden.

ACCIAIO INOX AISI 304 S/STEEL AISI 304



BACINELLE FORATE - PIERCED BASINS CUVETTES PERCÉES - LOCHSCHALE					
MOD. 2/1 Est. 646 x 530 mm Int. 620 x 500 mm 	GNT 21200	20(h) cm	60 L	184 €	
	GNT 21150	15(h) cm	44,9 L	160 €	
	GNT 21100	10(h) cm	31,5 L	120 €	
	GNT 2165	6,5(h) cm	18,9 L	100 €	
MOD. 1/1 Est. 530 x 325 mm Int. 500 x 300 mm 	GNT 11200	20(h) cm	30 L	91 €	
	GNT 11150	15(h) cm	20,6 L	74 €	
	GNT 11100	10(h) cm	13,3 L	48 €	
	GNT 1165	6,5(h) cm	8,5 L	43 €	
MOD. 2/3 Est. 352 x 325 mm Int. 329 x 300 mm 	GNT 23200	20(h) cm	19,3 L	62 €	
	GNT 23150	15(h) cm	13,6 L	52 €	
	GNT 23100	10(h) cm	8,9 L	37 €	
	GNT 2365	6,5(h) cm	5,5 L	35 €	
MOD. 1/2 Est. 325 x 265 mm Int. 300 x 238 mm 	GNT 12200	20(h) cm	11,6 L	58 €	
	GNT 12150	15(h) cm	9,9 L	45 €	
	GNT 12100	10(h) cm	8 L	34 €	
	GNT 1265	6,5(h) cm	4,2 L	23 €	



TEGLIE CON FONDO FORATO TRAYS WITH PERFORATED BOTTOM					
MOD. 2/1 Est. 646 x 530 mm Int. 620 x 500 mm		GNF 2120	2(h) cm	6,5 L	62 €
		GNF 2140	4(h) cm	12 L	70 €
		GNF 2165	6,5(h) cm	18,9 L	75 €
MOD. 1/1 Est. 530 x 325 mm Int. 500 x 300 mm		GNF 1120	2(h) cm	2,5 L	28 €
		GNF 1140	4(h) cm	5,5 L	33 €
		GNF 1165	6,5(h) cm	8,5 L	36 €
MOD. 2/3 Est. 352 x 325 mm Int. 329 x 300 mm		GNF 2320	2(h) cm	1,8 L	20 €
		GNF 2340	4(h) cm	3,5 L	23 €
		GNF 2365	6,5(h) cm	5,5 L	28 €
MOD. 1/2 Est. 325 x 265 mm Int. 300 x 238 mm		GNF 1220	2(h) cm	1,2 L	17 €
		GNF 1240	4(h) cm	2,5 L	19 €
		GNF 1265	6,5(h) cm	4,2 L	21 €

BACINELLE GN IN POLICARBONATO GN POLYCARBONATE CONTAINERS					
MOD. 1/1 Est. 530 x 325 mm Int. 500 x 300 mm		GNP 11200	20(h) cm	30 L	31 €
		GNP 11150	15(h) cm	20,6 L	30 €
		GNP 11100	10(h) cm	13,3 L	20 €
		GNP 1165	6,5(h) cm	8,5 L	21 €
		COPP 11	53 x 32,5 cm	-	12 €
		GFP 11	46 x 25,5 cm	-	9 €
MOD. 1/2 Est. 325 x 265 mm Int. 300 x 238 mm		GNP 12200	20(h) cm	11,6 L	19 €
		GNP 12150	15(h) cm	9,9 L	15 €
		GNP 12100	10(h) cm	8 L	12 €
		GNP 1265	6,5(h) cm	4,2 L	11 €
		COPP 12	32,5 x 26,5 cm	-	9 €
		GFP 12	25 x 19 cm	-	6 €



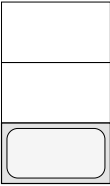
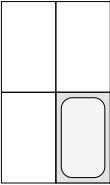
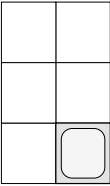
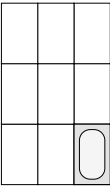

BACINELLE GN IN POLICARBONATO GN POLYCARBONATE CONTAINERS					
MOD. 1/3 Est. 325 x 176 mm Int. 300 x 150 mm 	GNP 13200	20(h) cm	8,1 L	16 €	
	GNP 13150	15(h) cm	5,9 L	13 €	
	GNP 13100	10(h) cm	3,8 L	9 €	
	GNP 1365	6,5(h) cm	2,5 L	8 €	
	COPP 13	32,5 x 17,6 cm	-	5 €	
	GFP 13	25 x 11 cm	-	4 €	
MOD. 1/4 Est. 265 x 162 mm INT. 238 x 136 mm 	GNP 14200	20(h) cm	4,9 L	12 €	
	GNP 14150	15(h) cm	4,1 L	10 €	
	GNP 14100	10(h) cm	2,5 L	8 €	
	GNP 1465	6,5(h) cm	1,9 L	7 €	
	COPP 14	26,5 x 16,2 cm	-	4 €	
	GFP 14	21 x 11 cm	-	4 €	
MOD. 1/6 Est. 176 x 162 mm Int. 140 x 153 mm 	GNP 16200	20(h) cm	3 L	10 €	
	GNP 16150	15(h) cm	2,5 L	7 €	
	GNP 16100	10(h) cm	1,6 L	6 €	
	GNP 1665	6,5(h) cm	1,1 L	5 €	
	COPP 16	17,6 x 16,2 cm	-	3 €	
	GFP 16	11,5 x 10 cm	-	3 €	
MOD. 1/9 Est. 176 x 108 mm Int. 140 x 100 mm 	GNP 19100	10(h) cm	0,9 L	4 €	
	GNP 1965	6,5(h) cm	0,5 L	4 €	
	COPP 19	17,6 x 10 cm	-	3 €	



VASCHE PER GELATO ICE CREAM CONTAINERS				
 VG 361615	VG 261612	26 x 16,5 x 12(h) cm	3,5 L	28 €
	VG 261615	26 x 16,5 x 15(h) cm	4 L	34 €
 VG 361612	VG 331612	33 x 16,5 x 8(h) cm	3,5 L	27 €
	VG 331612	33 x 16,5 x 12(h) cm	5 L	34 €
 VG 361615	VG 331615	33 x 16,5 x 15(h) cm	6,5 L	35 €
	VG 361618	36 x 16,5 x 8(h) cm	4 L	26 €
 VG 331612	VG 361612	36 x 16,5 x 12(h) cm	5,4 L	32 €
	VG 361615	36 x 16,5 x 15(h) cm	7 L	36 €
	VG 361618	36 x 16,5 x 18(h) cm	9 L	41 €
	VG 36258	36 x 25 x 8(h) cm	5 L	31 €
	VG 362512	36 x 25 x 12(h) cm	8 L	32 €



TEGLIE SMALTATE ENAMELLED TRAYS GN1/1			
	GNS 1120	GN1/1 20(h) cm	32 €
	GNS 1140	GN1/1 40(h) cm	34 €
	GNS 1165	GN1/1 65(h) cm	35 €

COPERCHI IN PLASTICA PLASTIC LIDS			
	CP 2	26,5 x 16,5 cm	11 €
	CP 3	33 x 16,5 cm	13 €
	CP 4	36 x 16,5 cm	15 €

SPATOLA - SPATULA			
	SPG	trasparente, rossa, blu, gialla Manico ø 26 cm Clear, red, blue, yellow Handle ø 26 cm	8 €

AV 4510



IT Morsa per prosciutto. Corpo in acciaio inox - supporto e manici in legno pregiato.

EN Ham stand. Stainless steel structure - support and handles in fine wood.

FR Serre-jambon. Corps en acier inox - support et poignées en bois de haute qualité.

DE Schinkengriff. Edelstahlkörper - Stütze und Griffe aus edlem Holz.

	AV4510
	58 x 25 x 19(h) cm
	190 €

AV 4515



IT Morsa per prosciutto. Corpo in acciaio - supporto e manici in legno.

EN Ham stand. Stainless steel structure - support and handles in fine wood.

FR Serre-jambon. Corps en acier - support et poignées en bois.

DE Schinkengriff. Edelstahlkörper - Stütze und Griffe aus edlem Holz.

	AV4515
	58 x 25 x 19(h) cm
	60 €

AV 4500

IT Apriscatole da banco. Struttura in acciaio cementato - coltello in acciaio inox - alzacoperchi magnetico max 20(h) cm.

EN Counter can opener. Case hardened steel structure - stainless steel knife - magnetic lid lifter max 20(h) cm.

FR Ouvre-boîte pour comptoir. Structure en acier cémenté - couteau en acier inox - souleveuse de couvercle magnétique max 20(h) cm.

DE Tisch-Dosenöffner. Einsatzgehärtete Stahlstruktur - Edelmessler - Magnetdeckelheber Max 20(h) cm.



	AV4500	OPTIONAL R4501	OPTIONAL R4502
	10 x 23 x 69(h) cm	Lama di ricambio Spare blade	Ingranaggio ricambio Spare gear
	115 €	19 €	19 €



Articoli vari per cucina
Cooking items

BL 4545



BP 4548



IT Bilancia Elettronica, fino a 15 kg con divisione in grammi 5. Corpo in ABS - piatto inox 28x21 cm - acquisizione tara - bolla di livello incorporata - tastiera con protezione antispruzzo - alimentazione a batteria ricaricabile - peso bilancia (batterie escluse) 4,1 kg. Non adatta per la vendita al pubblico.

EN Electronic Scale, up to 15 kg with division in 5 grams. - ABS casing - 28x21 cm stainless steel plate - tare acquisition - built-in level bubble - keyboard with splash protection - rechargeable battery power supply - scale weight (without batteries) 4,1 kg. Not suitable for retail sale.

FR Balance électronique, jusqu'à 15 kg avec division en 5 grammes. Corps en ABS - plaque en acier inox 28x21 cm - acquisition de la tare - bulle de niveau intégrée - clavier avec protection anti-rayures - alimentation par batterie rechargeable - poids balance (sans piles) 4,1 kg. Ne peut pas être vendue au public.

DE Elektronische Waage bis 15 kg mit Einteilung in Gramm 5. ABS Gehäuse - Edelstahltablette 28x21 cm - Tara-Erfassung - eingebaute Libelle - Tastatur mit Spritzschutz - Akku-Stromversorgung - Waagengewicht (ohne Batterien) 4,1 kg. Nicht für den Einzelhandel geeignet.

IT Bilancia Elettronica, fino a 60 kg con divisione in grammi 20. Corpo in ABS - piatto inox 32x33 cm - acquisizione tara - alimentazione a batteria + alimentatore - peso bilancia (batterie escluse) 4,5 kg. Non adatta per la vendita al pubblico.

EN Electronic Scale, up to 60 kg with division in 20 grams. ABS casing - 32x33 cm stainless steel plate - tare acquisition - battery power supply + transformer - scale weight (without batteries) 4,5 kg. Not suitable for retail sale.

FR Balance électronique, jusqu'à 60 kg avec division en 20 grammes. Corps en ABS - plaque en acier inox 32x33 cm - acquisition de la tare - alimentation par batterie + alimentation - poids de la balance (sans piles) 4,5 kg. Ne peut pas être vendue au public.

DE Elektronische Waage bis 60 kg mit Einteilung in Gramm 20. ABS Gehäuse - Edelstahltablette 32x33 cm - Tara-Erfassung - Akku-Stromversorgung + Netzteil - Waagengewicht (ohne Batterien) 4,5 kg. Nicht für den Einzelhandel geeignet.

	BL4545
	230V - 7 W
	29 x 33 x 22(h) cm
	368 €

	BP4548
	230V - 2 W
	31 x 30 x 5(h) cm
	296 €

AV 4960 - 61



IT Pala in alluminio forata per uso professionale.

EN Perforated aluminium peel for professional use.

FR Pelle en aluminium perforée pour usage professionnel.

DE Perforierte Aluminiumschaufel für den professionellen Einsatz.

i	AV4960	AV4961
↗ cm	33 x 33 x 170(h) cm	36 x 36 x 170(h) cm
	183 €	192 €

AV 4926 - 27 - 30



IT Pala in alluminio per uso professionale.

EN Aluminium peel for professional use.

FR Pelle en aluminium pour usage professionnel.

DE Aluminiumschaufel für den professionellen Einsatz.

i	AV4926	AV4927	AV4930/50
↗ cm	33 x 33 x 170(h) cm	36 x 36 x 170(h) cm	50 x 50 x 170(h) cm
	166 €	174 €	213 €

AV 4925 - 28 - 29



IT Pala in alluminio. FR Pelle pizza en aluminium.

EN Aluminium peel. DE Aluminiumschaufel.

i	AV4925	AV4928	AV4929
↗ cm	33 x 33 x 135(h) cm	33 x 33 x 170(h) cm	36 x 36 x 170(h) cm
	111 €	120 €	127 €

AV 4922 - 23



IT Palino in acciaio forato. FR Pelle de cuisson en acier perforé.

EN Perforated steel turning peel. DE Perforierter Brotschieber.

i	AV4922	AV4923
↗ cm	ø 18 x 170(h) cm	ø 22 x 170(h) cm
	120 €	127 €



AV 4920 - 21



IT Palino in acciaio.

FR Pelle de cuisson en acier.

EN Steel turning peel.

DE Brotschieber.

i	AV4920	AV4921
↗ cm	ø 18 x 170(h) cm	ø 22 x 170(h) cm
	116 €	112 €

AV 4965

IT Pala in alluminio forni elettrici e a gas.

EN Aluminium peel for electric and gas ovens.

FR Pelle en aluminium fours électriques et à gaz.

DE Aluminiumschaufel Elektro- und Gasöfen.

	AV4965
	33 x 35 x 70(h) cm
	66 €





AV 4966

IT Pala per pizza al metro.

EN Peel for pizza by the meter.

FR Pelle à pizza au mètre.

DE Pizza am Stück Schaufel.

	AV4966
	60 x 40 x 170(h) cm
	231 €



AV 4905 - AV 4931

IT Paletta servi pizza in acciaio.

EN Steel pizza serving peel.

FR Pelle pour servir des pizzas en acier.

DE Pizza-Service Stahlschaufel.



	AV4905	AV4931
	ø 50 cm a 8 porzioni ø 50 cm with 8 portions	ø 33 cm
	87 €	64 €

AV 4948

IT Paletta per pizza triangolare in acciaio.

EN Steel triangular pizza paddle.

FR Pelle triangulaire en acier pour pizza.

DE Dreieckiger Stahlschaufel für Pizza.



	AV4948
	15 x 25 cm
	50 €

AV 4932

IT Spatola in acciaio inox.

EN Stainless steel spatula.

FR Spatule en acier inox.

DE Edelstahlspachtel.



	AV4932
	19 €

AV 4954

IT Paletta per pizza in acciaio.

EN Steel pizza paddle.

FR Pelle à pizza en acier.

DE Stahlschaufel für Pizza.



	AV4954
	10 x 15 cm
	30 €

AV 4941

- IT Pinza prenditeglie.
EN Tray clamps.
FR Pincés prend plaques.
DE Blechklemme.



	AV4941
	47 €

AV 4949

- IT Rotella taglia pizza professionale.
EN Professional pizza cutter.
FR Roue coupe-pizza professionnelle.
DE Professionelles Pizzaschneidrad.



	AV4949
	ø 9 cm
	69 €

AV 4933

- IT Bucasfoglia in lega.
EN Alloy puff pastry perforator.
FR Perforateur de pâte feuilletée en alliage.
DE Legierung Blätterteiglöcherer.



	AV4933
	74 €

AV 4946

- IT Raschietto inox.
EN Stainless steel scraper.
FR Racloir inox.
DE Edelstahl Schaber.



	AV4946
	12 cm
	22 €

AV 4934

- IT Rotella taglia pizza ø 90 mm.
EN Pizza cutting wheel ø 90 mm.
FR Molette coupe pizza ø 90 mm.
DE Grädchen zur Pizza schneiden ø 90 mm.



	AV4934
	ø 9 cm
	27 €

AV 4911

- IT Paletta per cenere.
FR Pelle à cendres.
EN Peel for ashes.
DE Ascheschaufel.



	AV4911
	170(h) cm
	104 €

AV 4959



IT Spazzola ottone girevole a mezzaluna.

EN Brass swivel half-moon brush.

FR Brosse pivotante en laiton en forme de demi-lune.

DE Schwenkbare Halbmondbürste aus Messing.

	AV4959	OPTIONAL A45
	170(h) cm	ricambio spazzolone a mezzaluna spare half moon brush
	120 €	38 €

AV 4971



IT Spazzola doppia / ottone e raschietto in acciaio inox.

EN Double brush / brass and stainless steel scraper.

FR Brosse double / laiton et racloir inox.

DE Doppelbürste / Messing und Edelstahlschaber.

	AV4971	OPTIONAL A44
	110(h) cm	ricambio spazzola doppia spare double moon brush
	75 €	36 €

AV 4912



IT Spazzola in fibra naturale.

EN Natural fibre brush.

FR Brosse en fibres naturelles.

DE Naturfaserbürste.

	AV4912	OPTIONAL A42
	170(h) cm	Spazzola di ricambio in fibra naturale Natural fibre brush
	100 €	27 €

AV 4919



IT Spazzola in ottone per forni a legno.

EN Brass brush for wood ovens.

FR Brosse en laiton pour fours à bois.

DE Messingbürste für Holzöfen.

	AV4919	OPTIONAL A43
	170(h) cm	spazzola di ricambio in ottone Spare brass brush
	109 €	28 €

AV 4970



- IT Kit 3 pezzi 170(h) cm (pala ø 33 cm - palino ø 18 cm - spazzola).
- EN Kit 3 pieces 170(h) cm (ø 33 cm pizza peel - ø 18 cm turning peel - brush).
- FR Kit 3 pièces 170(h) cm (pelle ø 33 cm - pelle ø 18 cm - brosse).
- DE 3-teiliger Satz 170(h) cm (Schaufel ø 33 cm - kleine Schaufel ø 18 cm - Bürste).

	AV 4970
	170(h) cm
	280 €

AV 4972



- IT Kit 3 pezzi 135(h) cm (pala ø 33 cm - palino ø 22 cm - spazzola).
- EN Kit 3 pieces 135(h) cm (ø 33 cm pizza peel - ø 22 cm turning peel - brush).
- FR Kit 3 pièces 135(h) cm (pelle ø 33 cm - pelle ø 22 cm - brosse).
- DE 3-teiliger Satz 135(h) cm (Schaufel ø 33 cm - kleine Schaufel ø 22 cm - Bürste).

	AV 4972
	135(h) cm
	212 €

Accessori per pizzeria
Pizzeria accessories

	AV 4916	
	Cassetta per appoggio pale Peel support box Cassette pour support de pelles Schaufelstützkasten	
	83 €	

	AV 4913	
	Supporto reggipale a muro Wall peel support Support mural pour pelles Wandschaufelhalter	
	53 €	

	AV 4914	
	Supporto reggipale a muro Wall peel support Support mural pour pelles Wandschaufelhalter	
	62 €	

AV 4910

- IT Supporto reggipale.
- EN Peel support.
- FR Support de palles.
- DE Schaufelträger.

	AV 4910
	42 x 24 x 160(h) cm
	335 €



AV 4952 - AV 4953

- IT Retina tonda inox.
 EN Little round stainless steel net.
 FR Grille ronde en acier inox.
 DE Rundes Edelstahlnetz.



i	AV4952	AV4953
↗ cm	ø 33 cm	ø 45 cm
	26 €	40 €

AV 4918

- IT Alare per appoggio legna.
 EN Andiron stand for firewood.
 FR Chenet pour appui bois.
 DE Tragfläche für Holz.



i	AV4918
	96 €

AV 4956 - AV 4957

- IT Retina tonda alluminio.
 EN Little round aluminium net.
 FR Grille ronde en aluminium.
 DE Rundes Aluminiumnetz.



i	AV4956	AV4957
↗ cm	ø 33 cm	ø 45 cm
	18 €	25 €

AV 4938 - AV 4967 AV 4909 - AV 4939

- IT Contenitore per impasti pizza.
 EN Pizza dough container.
 FR Conteneur pour pâte à pizza.
 DE Pizzateigbehälter.



AV4939

i	AV4938	AV4967	AV4939 Coperchio/Cover	AV4909
↗ cm	60 x 40 x 7,5(h) cm	60 x 40 x 9(h) cm	60 x 40 cm	60 x 40 x 13(h) cm
	15 €	17 €	14 €	22 €



AV4938

AV4967

AV4909

AV 4973

- IT Portapizze rigido, interno in alluminio, per trasporto 10 pizze ø 33 cm.
EN Sturdy pizza holder, internally made of aluminium, for 10 pizzas ø 33 cm.
FR Conteneur thermique pour le transport de 10 pizza ø 33 cm, intérieur en aluminium.
DE Starres Pizzaregal aus Aluminium für den Transport von 10 Pizzas ø 33 cm.

	AV4973
	47 x 47 x 52(h) cm
	385 €



AV 4975

- IT Borsa termica 5 pizze ø 33 cm per consegna a domicilio.
EN Heating Bag for 5 pizzas ø 33 cm for home delivery.
FR Sac thermique pour 5 pizzas ø 33 cm pour la livraison à domicile.
DE Wärmetasche für den Heimlieferdienst enthält 5 Pizzas ø 33 cm.

	AV4975
	37 x 37 x 20(h) cm
	60 €



AV 4974

- IT Piastra di fissaggio al portapacchi ciclomotore (per art. AV4973).
EN Fixing plate for moped luggage rack (for art. AV4973).
FR Plaque de fixation sur le porte-bagages du cyclomoteur (pour art. AV4973).
DE Befestigungsplatte am Mopedgepäckträger (für Art. AV4973).

	AV4974
	35 x 37 x 6,5(h) cm
	110 €





Pattumiere - portarifiuti

GARBAGE AND DUST BINS
POUBELLES
MÜLL- UND ABFALLBEHÄLTER

AV4650-51

- IT Posacenere, gettacarte, pattumiere e portarifiuti - coperchio a rete cromata.
- EN Ashtrays, paper baskets, garbage bins and dust bins - chromed mesh lid.
- FR Cendriers, corbeilles à papier, poubelles et conteneur de déchets - couvercle en filet chromé.
- DE Aschenbecher, Papierkorb, Mülleimer und Abfallbehälter - verchromter Netzdeckel.

	AV4650	AV4651
	ø 20 - 60(h) cm	ø 25 - 70(h) cm
	115 €	175 €



AV4620

- IT Gettacarte in acciaio inox satinato Autoestinguente, testa soffocante per l'arresto della propagazione del fuoco - capacità 50 L - base in gomma.
- EN Satin stainless steel paper basket, Self-extinguishing, stifling end to stop the propagation of fire - capacity 50 L - rubber base.
- FR Corbeille à papier en acier inox satiné, Eteignant automatiquement, tête suffocante pour arrêter la propagation du feu - capacité 50 L - base en caoutchouc.
- DE Papierkorb aus satiniertem Edelstahl, Selbstlöschend erstickender Deckel zur Verhinderung der Ausbreitung von Feuer - Kapazität 50 L - Gummifuß.

	AV4620
	ø 31 - 59(h) cm
	160 €



AV4666-80

- IT Tramoggia su ruote. Struttura in acciaio inox satinato. coperchio asportabile.
- EN Hopper on wheels. Satin stainless steel casing. Removable lid.
- FR Trémie sur roues. Corps en acier inox satiné. Couvercle amovible.
- DE Trichter auf Rädern. Gehäuse aus Edelstahl matt geschliffen. Abnehmbarer Deckel.



	AV4666	AV4680 con separatore interno with internal separator
	61 x 40 x 73(h) cm	61 x 40 x 73(h) cm
	115 L	
	465 €	550 €

AV4671

- IT Pattumiera con ruote, senza pedale.
- EN Garbage bin with wheels, without pedal.
- FR Poubelle à roulettes, sans pédale.
- DE Mülleimer mit Rädern, ohne Fußhebel.

	AV4671
	ø 40 x 76(h) cm
	70 L
	267 €



Pattumiere e portarifiuti
Garbage and dust bins

AV4667
AV4668

AV4669

AV4660 - AV4661
AV4663



IT Portarifiuti carrellato. Struttura a forma cilindrica in acciaio inox - completo di coperchio stampato - fondo a tenuta stagna - ruote multidirezionali. AV4667-68 con comando a pedale.

EN Wheeled waste bin. Cylindrical stainless steel structure - Complete with shaped lid - watertight bottom - multidirectional wheels. AV4667-68 with pedal control.

FR Chariot-poubelle. Corps cylindrique en acier inox - complète de couvercle imprimée - fond étanche - roues multidirectionnelles. AV4667-68 avec commande à pédale.

DE Abfalleimer auf Rädern. Zylindrisches Edelstahlgehäuse - mit vorgeformtem Deckel - wasserdichter Boden - Mehrwegräder. AV4667-68 mit Fußhebel.

	AV4667	AV4668	AV4669
	ø 39 x 60(h) cm	ø 46 x 70(h) cm	ø 46 x 70(h) cm
	50 L	100 L	100 L
	230 €	265 €	200 €



IT Pattumiere tonde in acciaio inox. Cestello interno in metallo e pedale.

EN Round stainless steel waste bins. Internal metal basket and pedal.

FR Poubelles rondes en acier inox. Boîtier interne en métal et pédale.

DE Runde Abfalleimer aus Edelstahl. Interner Metallkorb und Fußhebel.

	AV4660	AV4661	AV4663
	ø 32 x 59(h) cm	ø 32 x 74(h) cm	ø 41 x 71(h) cm
	30 L	40 L	80 L
	270 €	295 €	510 €

AV4652 AV4654



AV 4652

AV4681



IT Pattumiera rettangolare - Struttura in acciaio inox comando apertura a pedale - estrazione sacco anteriore - 2 ruote.

EN Rectangular waste bin - Stainless steel structure pedal opening control - front bag extraction - 2 wheels.

FR Poubelle rectangulaire - Corps en acier inox commande d'ouverture par pédale - extraction du sac à l'avant - 2 roues.

DE Rechteckiger Abfalleimer - Gehäuse aus Edelstahl Fußhebelöffnung - vordere Sackentnahme - 2 Räder.

IT Pattumiera portasacco. Attacco rotondo in acciaio inox coperchio con apertura a pedale.

EN Bag holder. Round stainless steel fitting, lid with pedal opening.

FR Poubelle Porte-sac. Support rond en acier inox couvercle avec ouverture par pédale.

DE Müllsackhalterung. Runder Edelstahldeckel mit Fußhebelöffnung.

i	AV4652	AV4654
cm	49 x 50 x 101(h) cm	49 x 50 x 79(h) cm
L	100 L	70 L
	550 €	495 €

i	AV4681
cm	55 x 45 x 85(h) cm
L	sacco grande / big bag
	230 €

Pattumiere e portarifiuti
Garbage and dust bins

CA1602 - CA1603



IT Carrelli portasacco con struttura a X. Disponibile con cestino e struttura verniciata (CA1602) o con comando a pedale e struttura cromata (CA 1603). Attacco rotondo - coperchio in plastica rotondo con aggancio.

EN Bag holder trolleys with X structure. Available with basket and painted structure (CA1602) or with pedal control and chromed structure (CA 1603). Round fitting - round plastic lid with fastener.

FR Chariots porte-sac en forme de X. Disponible avec boîtier et structure peinte (CA1602) ou avec commande à pédale et structure chromée (CA 1603). Support rond - couvercle rond en plastique avec raccord.

DE Müllsackwagen mit X-förmige Struktur. Erhältlich mit Korb und lackierter Struktur (CA1602) oder mit Fußhebelöffnung und verchromter Struktur (CA 1603). Runder Anschluss - runder Kunststoffdeckel mit Aufhängung.

	CA1602	CA1603
	58 x 56 x 102(h) cm	
	230 €	265 €

AV4682



IT Pattumiere in polietilene per raccolta differenziata - Struttura colore grigio - coperchio colorato a scelta. Ruote ø 143 mm.

EN Polyethylene waste bins for differentiated collection - Grey structure - coloured lid of your choice. Wheels ø 143 mm.

FR Poubelles en polyéthylène pour collecte différenciée - Structure de couleur grise - couvercle de couleur de votre choix. Roues ø 143 mm.

DE Abfalleimer aus Polyethylen zur getrennten Entsorgung - graue Struktur - farbiger Deckel Ihrer Wahl. Räder ø 143 mm.

	AV4682Y giallo/yellow	AV4682R rosso/red	AV4682B blu/blue	AV4682G verde/green	AV4682W bianco/white
	54 x 49 x 85(h) cm				
	80 L				
	57 €				

AV4675



AV4674



AV4676



AV4678



AV4679



IT Pattumiere in polietilene.
Diversi colori disponibili.
Ruote ø 200 mm.

EN Polyethylene waste bins.
Several colours available.
Wheels ø 200 mm.

FR Poubelles en polyéthylène.
Différentes couleurs disponibles.
Roues ø 200 mm.

DE Abfalleimer aus Polyethylen.
Erhältlich in verschieden Farben.
Räder ø 200 mm.

OPTIONAL RC 0075

Pedale apricoperchio per contenitore
Pedal lid opener for container
Pédale ouvre-couvercle pour conteneur
Deckelöffnungsfußhebel

62 €

	AV4674	AV4675	AV4676	AV4678	AV4679
	55 x 48 x 93(h) cm				
	120 L				
	95 €				

Pattumiere e portarifiuti
Garbage and dust bins



NEUTRO INOX

STEEL FURNITURE





IT Tavoli da lavoro su gambe con ripiano inferiore

Senza alzatina - profondità 600 o 700 mm. Struttura in acciaio inox - piano di lavoro in acciaio inox AISI 304 - piano di lavoro e ripiano inferiore piegati e saldati - ripiano inferiore con rinforzo ad Omega - facile montaggio con viti incluse - piedini regolabili.

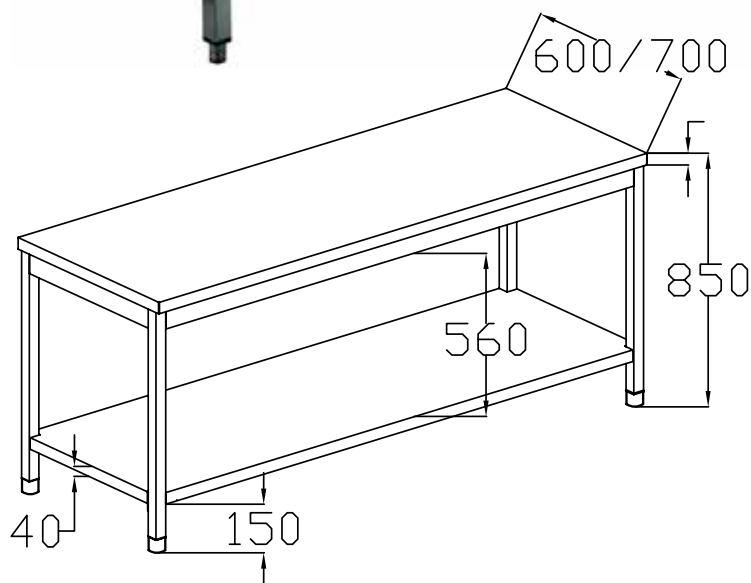
EN Working Tables with undershelf

Without backslash - depth 600 or 700 mm. Stainless Steel Structure - AISI 304 Stainless steel working top - working top and bottom shelves folded and welded - bottom shelf with Omega reinforcement crossbar - easy assembly with included screws - adjustable feet.



					
	mm	mm	Kg	Kg	€
GDATS66	600 x 600 x 850(h)	910 x 680 x 160(h)	16,6	19,1	290
GDATS76	700 x 600 x 850(h)	910 x 680 x 160(h)	18,4	21	300
GDATS86	800 x 600 x 850(h)	910 x 680 x 160(h)	20,3	23	320
GDATS106	1000 x 600 x 850(h)	1050 x 640 x 160(h)	23,6	26,5	350
GDATS126	1200 x 600 x 850(h)	1250 x 640 x 160(h)	27	30	385
GDATS146	1400 x 600 x 850(h)	1450 x 640 x 280(h)	30,4	35	425
GDATS156	1500 x 600 x 850(h)	1550 x 640 x 280(h)	32	37	445
GDATS166	1600 x 600 x 850(h)	1650 x 640 x 280(h)	34	39	450
GDATS186	1800 x 600 x 850(h)	1850 x 640 x 280(h)	37	42	485
GDATS206	2000 x 600 x 850(h)	2050 x 640 x 280(h)	45,5	51	520
GDATS67	600 x 700 x 850(h)	910 x 780 x 160(h)	18,5	21	305
GDATS77	700 x 700 x 850(h)	910 x 780 x 160(h)	20,3	23	325
GDATS87	800 x 700 x 850(h)	910 x 780 x 160(h)	22,5	25,4	340
GDATS107	1000 x 700 x 850(h)	1050 x 740 x 160(h)	26	29,2	375
GDATS127	1200 x 700 x 850(h)	1250 x 740 x 160(h)	30	33,6	410
GDATS147	1400 x 700 x 850(h)	1450 x 740 x 280(h)	34,4	39	445
GDATS157	1500 x 700 x 850(h)	1550 x 740 x 280(h)	36,2	41	470
GDATS167	1600 x 700 x 850(h)	1650 x 740 x 280(h)	38,1	43	485
GDATS187	1800 x 700 x 850(h)	1850 x 740 x 280(h)	44	49	520
GDATS207	2000 x 700 x 850(h)	2050 x 740 x 280(h)	46	52	560

Tavoli da lavoro
Working tables

IT Tavoli da lavoro su gambe con ripiano inferiore

Con alzatina - profondità 600 o 700 mm. Struttura in acciaio inox - piano di lavoro in acciaio inox AISI 304 con alzatina tamburata h 100 mm. Piano di lavoro e ripiano inferiore piegati e saldati - ripiano inferiore con rinforzo ad Omega - facile montaggio con viti incluse - piedini regolabili.

EN Working Tables with undershelf

With backsplash - depth 600 or 700 mm. Stainless Steel Structure - AISI 304 Stainless steel working top with h 100 mm, hollow-core backsplash. Working top and bottom shelves folded and welded - bottom shelf with Omega reinforcement crossbar - easy assembly with included screws - adjustable feet.









	mm	mm	NET Kg	GROSS Kg	€
GDATS66A	600 x 600 x 950(h)	910 x 680 x 240(h)	17,4	20	310
GDATS76A	700 x 600 x 950(h)	910 x 680 x 240(h)	19,2	22	320
GDATS86A	800 x 600 x 950(h)	910 x 680 x 240(h)	21,6	24,6	345
GDATS106A	1000 x 600 x 950(h)	1050 x 640 x 240(h)	24	27,5	375
GDATS126A	1200 x 600 x 950(h)	1250 x 640 x 240(h)	28,5	32	415
GDATS146A	1400 x 600 x 950(h)	1450 x 640 x 240(h)	32,3	36	450
GDATS156A	1500 x 600 x 950(h)	1550 x 640 x 360(h)	33,4	38	475
GDATS166A	1600 x 600 x 950(h)	1650 x 640 x 360(h)	34,5	40	490
GDATS186A	1800 x 600 x 950(h)	1850 x 640 x 360(h)	38	44	525
GDATS206A	2000 x 600 x 950(h)	2050 x 640 x 360(h)	41	49	560
GDATS67A	600 x 700 x 950(h)	910 x 780 x 240(h)	19,8	23,1	320
GDATS77A	700 x 700 x 950(h)	910 x 780 x 240(h)	20,8	24,2	335
GDATS87A	800 x 700 x 950(h)	910 x 780 x 240(h)	23,9	27,4	360
GDATS107A	1000 x 700 x 950(h)	1050 x 740 x 240(h)	26,6	30,5	395
GDATS127A	1200 x 700 x 950(h)	1250 x 740 x 240(h)	31,2	35,3	435
GDATS147A	1400 x 700 x 950(h)	1450 x 740 x 240(h)	34,7	39	475
GDATS157A	1500 x 700 x 950(h)	1550 x 740 x 360(h)	38,5	44	505
GDATS167A	1600 x 700 x 950(h)	1650 x 740 x 360(h)	41,5	47	515
GDATS187A	1800 x 700 x 950(h)	1850 x 740 x 360(h)	43	49	560
GDATS207A	2000 x 700 x 950(h)	2050 x 740 x 360(h)	46,3	54	600

IT Tavoli armadiati con porte battenti

Senza alzatina - profondità 600 o 700 mm. Struttura in acciaio inox - piano di lavoro in acciaio inox AISI 304 - ripiano intermedio regolabile con rinforzo ad Omega - porte tamburate - pannello posteriore in acciaio Inox, 66/86, 67/87 con porte a battente - piedini regolabili.

EN Working cabinets with hinged doors

Without backsplash - depth 600 or 700 mm. Stainless Steel Structure - AISI 304 Stainless steel working top - adjustable middle shelf with Omega reinforcement crossbar - hollow core doors - Stainless steel back panel, 66/86, 67/87 with hinged doors - adjustable feet.

	 mm	 mm	 NET Kg	 GROSS Kg	
GDASR66	600 x 600 x 850(h)	620 x 620 x 850(h)	29	35	560
GDASR86	800 x 600 x 850(h)	820 x 620 x 850(h)	35,5	41	595
GDASR67	600 x 700 x 850(h)	620 x 720 x 850(h)	32	38	590
GDASR87	800 x 700 x 850(h)	820 x 720 x 850(h)	32	46	615

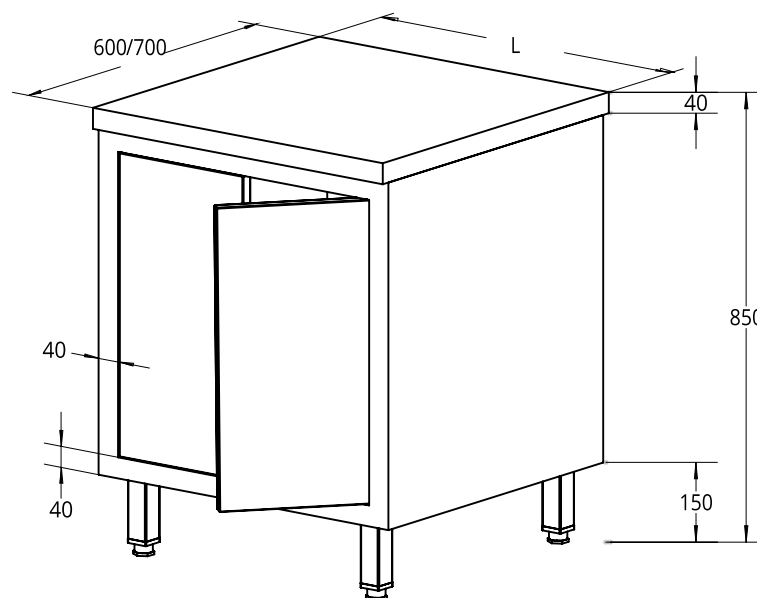

OPTIONAL

RUO100
kit 4 ruote / 4 wheel ø100
80 €

Tavoli armadiati
Working cabinets





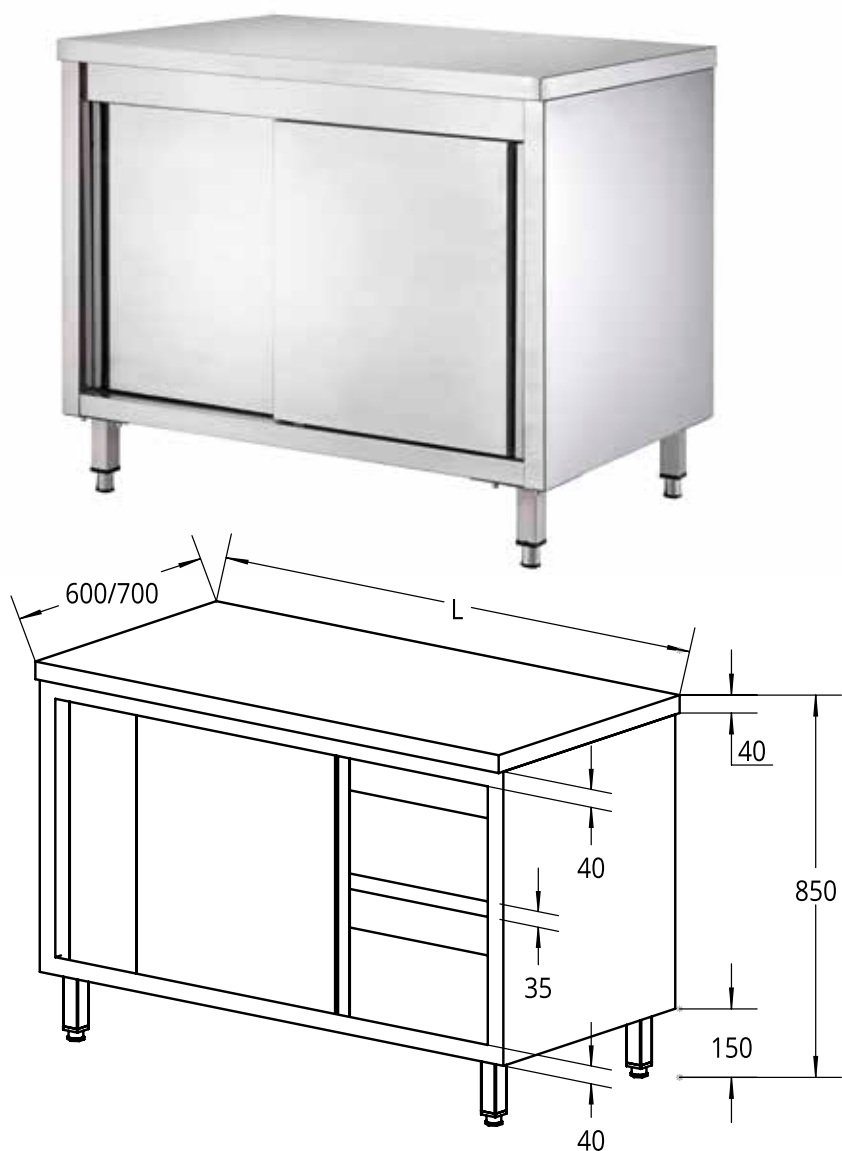

IT Tavoli armadiati con porte scorrevoli

Senza alzatina - profondità 600 o 700 mm. Struttura in acciaio inox - piano di lavoro in acciaio inox AISI 304 - ripiano intermedio regolabile con rinforzo ad Omega - porte tamburate - pannello posteriore in acciaio inox, 66/86, 67/87 con porte a battente - piedini regolabili.

EN Working cabinets with sliding doors

Without backsplash - depth 600 or 700 mm. Stainless Steel Structure - AISI 304 Stainless steel working top - adjustable middle shelf with Omega reinforcement crossbar - hollow core doors - Stainless steel back panel, 66/86, 67/87 with hinged doors - adjustable feet.



	 mm	 mm	 NET Kg	 GROSS Kg	
GDASR106	1000 x 600 x 850(h)	1020 x 620 x 850(h)	43	51	665
GDASR126	1200 x 600 x 850(h)	1220 x 620 x 850(h)	50	61	740
GDASR146	1400 x 600 x 850(h)	1420 x 620 x 850(h)	55	68	800
GDASR156	1500 x 600 x 850(h)	1520 x 620 x 850(h)	57	72	825
GDASR166	1600 x 600 x 850(h)	1620 x 620 x 850(h)	59,7	75	855
GDASR186	1800 x 600 x 850(h)	1820 x 620 x 850(h)	69,5	83	960
GDASR206	2000 x 600 x 850(h)	2020 x 620 x 850(h)	77,5	91	1.030
GDASR107	1000 x 700 x 850(h)	1020 x 720 x 850(h)	47,5	56	685
GDASR127	1200 x 700 x 850(h)	1220 x 720 x 850(h)	54,5	64	765
GDASR147	1400 x 700 x 850(h)	1420 x 720 x 850(h)	62	74	825
GDASR157	1500 x 700 x 850(h)	1520 x 720 x 850(h)	52	71	855
GDASR167	1600 x 700 x 850(h)	1620 x 720 x 850(h)	66	81	890
GDASR187	1800 x 700 x 850(h)	1820 x 720 x 850(h)	76,5	89	990
GDASR207	2000 x 700 x 850(h)	2020 x 720 x 850(h)	83	98	1.065

OPTIONAL

RUO100
kit 4 ruote / 4 wheel ø100
80 €







IT Tavoli armadiati con porte battenti

Con alzatina - profondità 600 o 700 mm. Struttura in acciaio inox - piano di lavoro in acciaio inox AISI 304 - ripiano intermedio regolabile con rinforzo ad Omega - alzatina h 100 mm tamburata - porte tamburate - pannello posteriore in acciaio Inox, 66/86, 67/87 con porte a battente - piedini regolabili.

EN Working cabinets with hinged doors

With backsplash - depth 600 or 700 mm. Stainless Steel Structure - AISI 304 Stainless steel working top - adjustable middle shelf with Omega reinforcement crossbar - h 100 mm hollow-core backsplash - hollow core doors - Stainless steel back panel 66/86, 67/87 with hinged doors - adjustable feet.



	 mm	 mm	 NET Kg	 GROSS Kg	
GDASR66A	600 x 600 x 950(h)	620 x 620 x 950(h)	27	38	590
GDASR86A	800 x 600 x 950(h)	820 x 620 x 950(h)	36,5	45	625
GDASR67A	600 x 700 x 950(h)	620 x 720 x 950(h)	30	42	605
GDASR87A	800 x 700 x 950(h)	820 x 720 x 950(h)	36	50	645

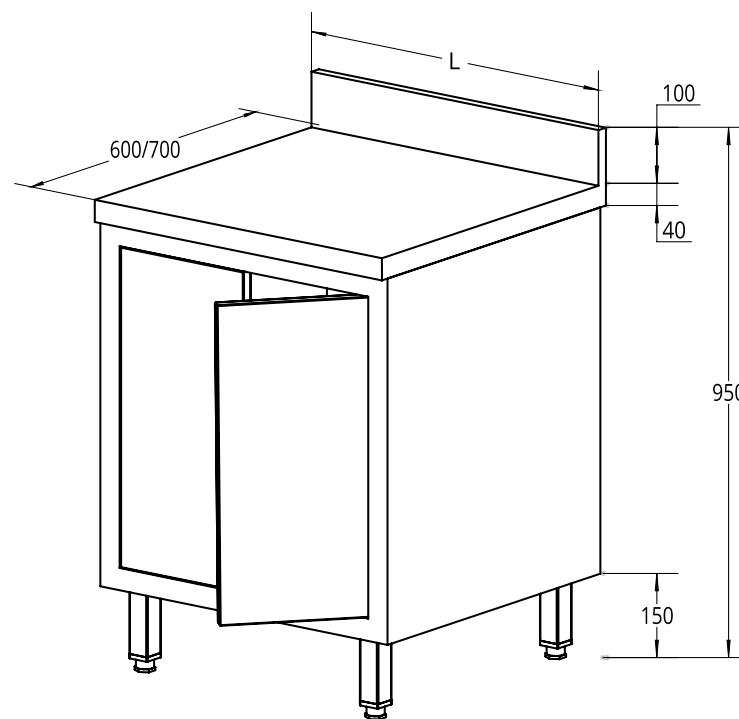

OPTIONAL

RUO100
kit 4 ruote / 4 wheel ø100
80 €

Tavoli armadiati
Working cabinets







IT Tavoli armadiati con porte scorrevoli

Con alzatina - profondità 600 o 700 mm. Struttura in acciaio inox - piano di lavoro in acciaio inox AISI 304 - ripiano intermedio regolabile con rinforzo ad Omega - alzatina h 100 mm tamburata - porte tamburate - pannello posteriore in acciaio Inox, 66/86, 67/87 con porte a battente - piedini regolabili.

EN Working cabinets with sliding doors

With backsplash - depth 600 or 700 mm. Stainless Steel Structure - AISI 304 Stainless steel working top - adjustable middle shelf with Omega reinforcement crossbar - h 100 mm hollow-core backsplash - hollow core doors - Stainless steel back panel 66/86, 67/87 with hinged doors - adjustable feet.



	 mm	 mm	 NET Kg	 GROSS Kg	
GDASR106A	1000 x 600 x 950(h)	1020 x 620 x 950(h)	43,5	54	695
GDASR126A	1200 x 600 x 950(h)	1220 x 620 x 950(h)	51	65	775
GDASR146A	1400 x 600 x 950(h)	1420 x 620 x 950(h)	58	70	835
GDASR156A	1500 x 600 x 950(h)	1520 x 620 x 950(h)	62,5	76	880
GDASR166A	1600 x 600 x 950(h)	1620 x 620 x 950(h)	64,7	80	915
GDASR186A	1800 x 600 x 950(h)	1820 x 620 x 950(h)	72	87	1.005
GDASR206A	2000 x 600 x 950(h)	2020 x 620 x 950(h)	79	97	1.080
GDASR107A	1000 x 700 x 950(h)	1020 x 720 x 950(h)	49	62	720
GDASR127A	1200 x 700 x 950(h)	1220 x 720 x 950(h)	57	69	800
GDASR147A	1400 x 700 x 950(h)	1420 x 720 x 950(h)	64	77	865
GDASR157A	1500 x 700 x 950(h)	1520 x 720 x 950(h)	67	82	915
GDASR167A	1600 x 700 x 950(h)	1620 x 720 x 950(h)	72	86	935
GDASR187A	1800 x 700 x 950(h)	1820 x 720 x 950(h)	82	97	1.040
GDASR207A	2000 x 700 x 950(h)	2020 x 720 x 950(h)	86	104	1.120

OPTIONAL







RUO100
kit 4 ruote / 4 wheel ø100
80 €

IT Tavoli armadiati ad angolo

Senza alzatina o con alzatina - struttura in acciaio inox - piano di lavoro in acciaio inox AISI 304 - ripiano intermedio regolabile con rinforzo ad Omega - alzatina h 100 mm tamburata - porte tamburate - pannello posteriore in acciaio Inox - piedini regolabili.

EN Working corner cabinets

Without backsplash or with backsplash - stainless Steel Structure - AISI 304 Stainless steel working top - adjustable middle shelf with Omega reinforcement crossbar - h 100 mm hollow-core backsplash - hollow core doors - Stainless steel back panel - adjustable feet.

	 mm	 mm	 NET Kg	 GROSS Kg	
GDCC996	900 x 900 x 600 x 850(h)	920 x 920 x 850(h)	43,5	55	805
GDCC10107	1000 x 1000 x 700 x 850(h)	1020 x 1020 x 850(h)	50,5	63	855
CON ALZATINA - WITH BACKSPLASH					
GDCC996A	900 x 900 x 600 x 950(h)	920 x 920 x 950(h)	40	53	870
GDCC10107A	1000 x 1000 x 700 x 950(h)	1020 x 1020 x 950(h)	48	61	925

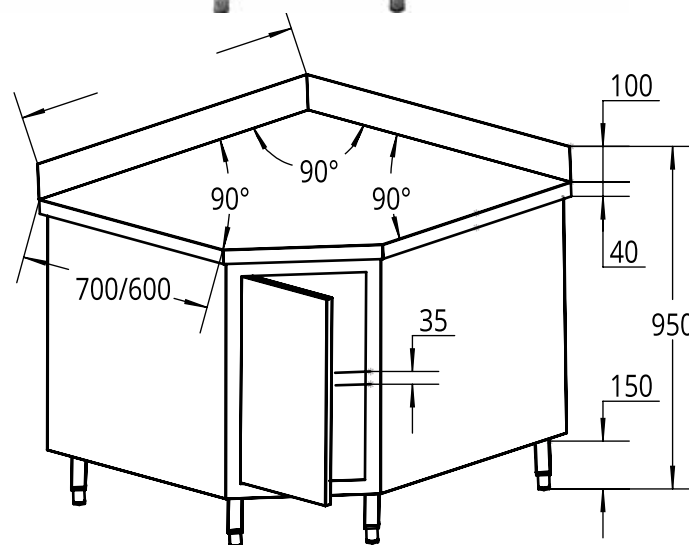
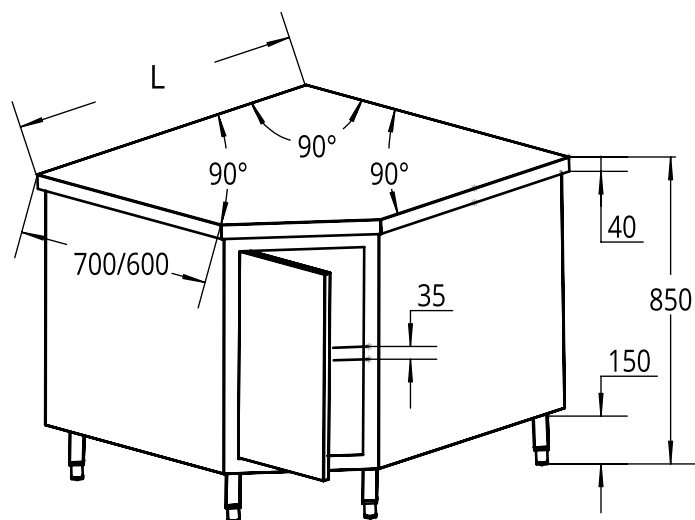

IT Armadi in acciaio inossidabile con ante scorrevoli







Profondità 600 o 700 mm. Struttura in acciaio inox - ripiano intermedio regolabile con rinforzo ad Omega - porte tamburate - pannello posteriore in acciaio Inox - piedini regolabili.

EN Sliding doors Stainless steel cabinets

Depth 600 or 700 mm - Stainless Steel Structure - adjustable middle shelf with Omega reinforcement crossbar - hollow core doors - Stainless steel back panel adjustable feet.







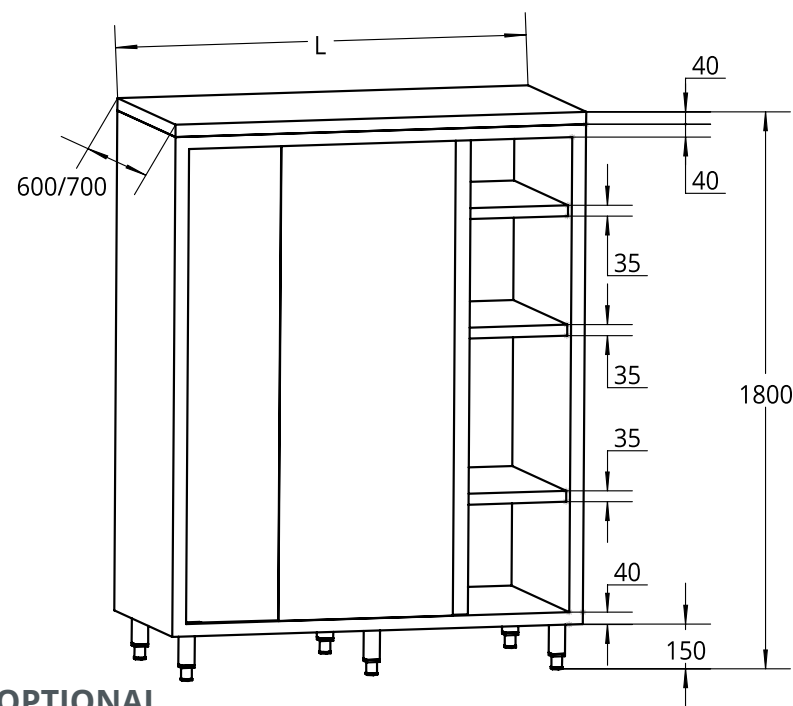

COMPRESI 3 RIPIANI
3 SHELF INCLUDED

	 mm	 mm	 NET Kg	 GROSS Kg	 €
GDSCS126	1200 x 600 x 1800(h)	1220 x 620 x 1940(h)	86,5	97	1.570
GDSCS146	1400 x 600 x 1800(h)	1420 x 620 x 1940(h)	100	114	1.695
GDSCS166	1600 x 600 x 1800(h)	1620 x 620 x 1940(h)	110	125	1.820
GDSCS127	1200 x 700 x 1800(h)	1220 x 720 x 1940(h)	95,5	107	1.620
GDSCS147	1400 x 700 x 1800(h)	1420 x 720 x 1940(h)	106,7	120	1.750
GDSCS167	1600 x 700 x 1800(h)	1620 x 720 x 1940(h)	118	132	1.875



OPTIONAL RIPIANO / SHELF







	 mm	 €		 mm	 €
SHELF126	1200 x 600	125	SHELF127	1200 x 700	125
SHELF146	1400 x 600	145	SHELF147	1400 x 700	150
SHELF166	1600 x 600	180	SHELF167	1600 x 700	185

IT Pensili con ante a battente

Struttura in acciaio inox - ripiano intermedio regolabile con rinforzo ad Omega - porte tamburate - staffe di montaggio a muro incluse.

EN Hinged doors wall cupboards

Stainless Steel Structure - adjustable middle shelf with Omega reinforcement crossbar - hollow core doors - wall mounting racks included.

	 mm	 mm	 NET Kg	 GROSS Kg	
GDWCH64	600 x 400 x 650(h)	660 x 460 x 800(h)	18,4	23	380
GDWCH84	800 x 400 x 650(h)	860 x 460 x 800(h)	22,7	27	395

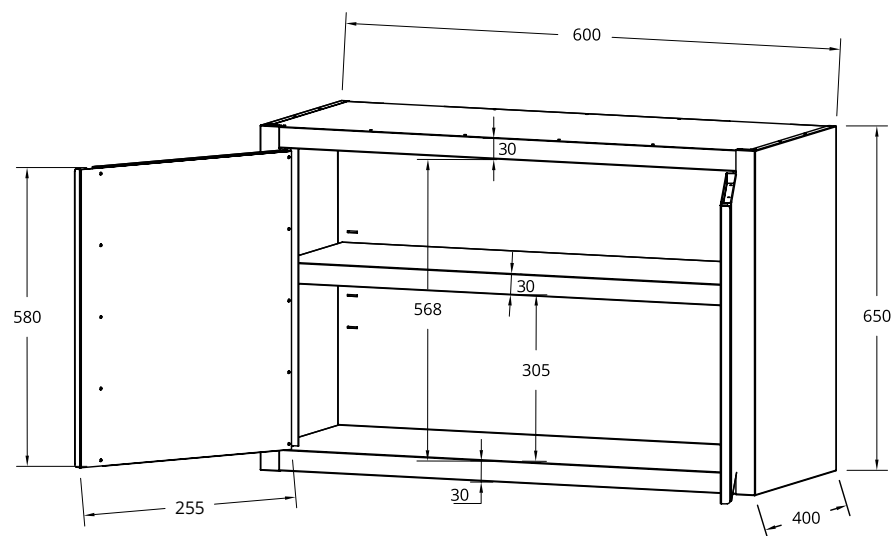

Pensili
Wall cupboards







IT Pensili con ante scorrevoli

Struttura in acciaio inox - ripiano intermedio regolabile con rinforzo ad Omega - porte tamburate - staffe di montaggio a muro incluse.

EN Sliding doors wall cupboards

Stainless Steel Structure - adjustable middle shelf with Omega reinforcement crossbar - hollow core doors - wall mounting racks included.



					
	mm	mm	NET Kg	GROSS Kg	€
GDWCS104	1000 x 400 x 650(h)	1060 x 460 x 800(h)	27,2	34	420
GDWCS124	1200 x 400 x 650(h)	1260 x 460 x 800(h)	31,7	39	465
GDWCS144	1400 x 400 x 650(h)	1460 x 460 x 800(h)	36,3	46	510
GDWCS164	1600 x 400 x 650(h)	1660 x 460 x 800(h)	41,2	52	590
GDWCS184	1800 x 400 x 650(h)	1860 x 460 x 800(h)	46	57	640
GDWCS204	2000 x 400 x 650(h)	2060 x 460 x 800(h)	50,2	62	690

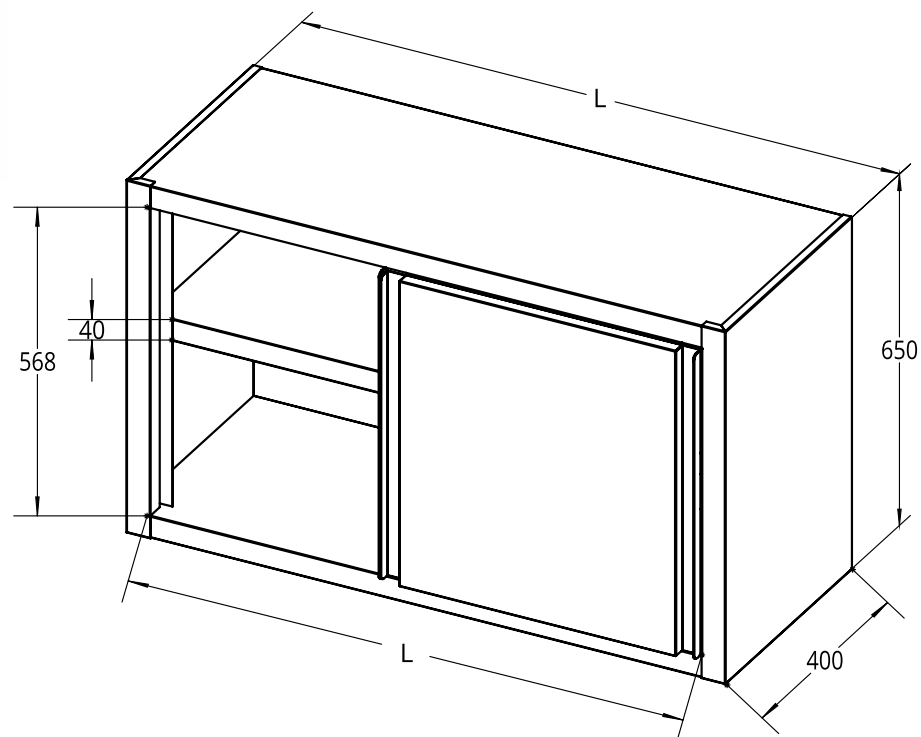







IT Pensili aperti

Struttura in acciaio inox - ripiano intermedio regolabile con rinforzo ad Omega - staffe di montaggio a muro incluse.

EN Open wall cupboards

Stainless Steel Structure - adjustable middle shelf with Omega reinforcement crossbar - wall mounting racks included.

					
	mm	mm	NET Kg	GROSS Kg	€
GDWCO64	600 x 400 x 650(h)	660 x 460 x 800(h)	12,6	18	270
GDWCO84	800 x 400 x 650(h)	860 x 460 x 800(h)	15	21	280
GDWCO104	1000 x 400 x 650(h)	1060 x 460 x 800(h)	18,7	25	315
GDWCO124	1200 x 400 x 650(h)	1260 x 460 x 800(h)	22,2	30	350
GDWCO144	1400 x 400 x 650(h)	1460 x 460 x 800(h)	24,3	33	385
GDWCO164	1600 x 400 x 650(h)	1660 x 460 x 800(h)	27,4	38	430
GDWCO184	1800 x 400 x 650(h)	1860 x 460 x 800(h)	30,3	41	470
GDWCO204	2000 x 400 x 650(h)	2060 x 460 x 800(h)	31,8	44	525

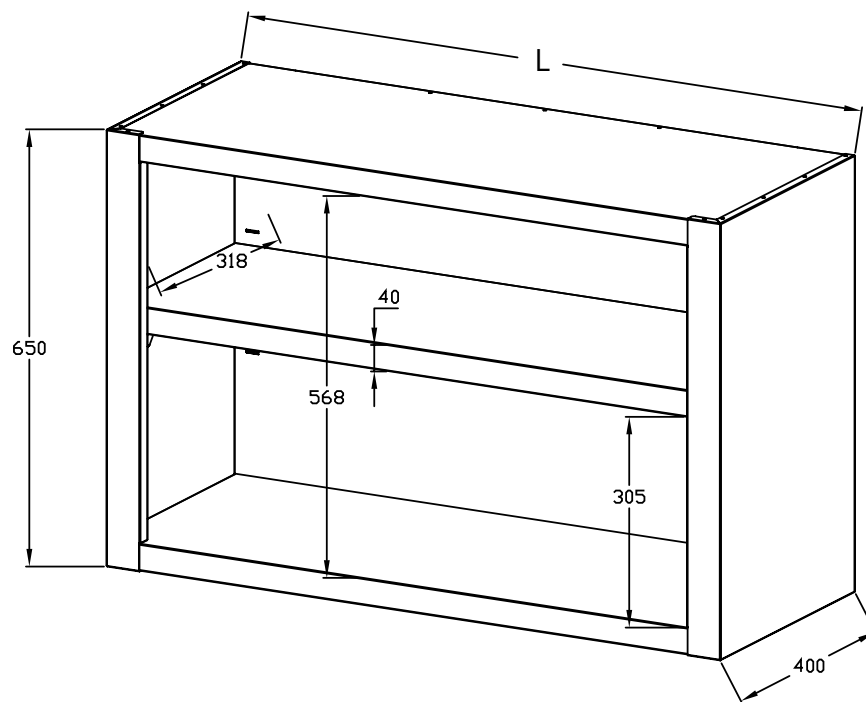

IT Mensole in acciaio inox

Struttura in acciaio inox - altezza ripiano 30 mm o 40 mm - alzatina posteriore h 30 mm staffe montaggio a muro incluse h 400 mm. Le staffe possono essere sovrapposte per ottenere più livelli.

EN Stainless Steel Shelves







Stainless Steel Structure - shelf height 30 mm or 40 mm - backsplash h 30 mm - wall mounting racks h 400 mm included - racks can be stacked to obtain multiple levels.



GDWBS1R84



GDWBS1R84 X 2







	 mm	 mm	 Kg	 Kg	
GDWB S1R63	600 x 300 x 400(h)	610 x 350 x 95(h)	2,8	3,6	85
GDWB S1R83	800 x 300 x 400(h)	810 x 350 x 95(h)	3	4	95
GDWB S1R103	1000 x 300 x 400(h)	1010 x 350 x 95(h)	3.7	4.7	100
GDWB S1R123	1200 x 300 x 400(h)	1210 x 350 x 95(h)	4	5	125
GDWB S1R143	1400 x 300 x 400(h)	1410 x 350 x 95(h)	4.3	5.4	135
GDWB S1R163	1600 x 300 x 400(h)	1610 x 350 x 95(h)	5.6	6.7	155
GDWB S1R183	1800 x 300 x 400(h)	1810 x 350 x 95(h)	6.2	7.4	175
GDWB S1R203	2000 x 300 x 400(h)	2010 x 350 x 95(h)	6,8	8	205
GDWB S1R64	600 x 400 x 400(h)	610 x 450 x 95(h)	3,4	4,2	95
GDWB S1R84	800 x 400 x 400(h)	810 x 450 x 95(h)	4	4,9	105
GDWB S1R104	1000 x 400 x 400(h)	1010 x 450 x 95(h)	4,5	5,5	110
GDWB S1R124	1200 x 400 x 400(h)	1210 x 450 x 95(h)	5,1	6,1	145
GDWB S1R144	1400 x 400 x 400(h)	1410 x 450 x 95(h)	5,8	6,8	155
GDWB S1R164	1600 x 400 x 400(h)	1610 x 450 x 95(h)	7	8	185
GDWB S1R184	1800 x 400 x 400(h)	1810 x 450 x 95(h)	7,6	8,7	195
GDWB S1R204	2000 x 400 x 400(h)	2010 x 450 x 95(h)	8	9,3	230

IT Lavelli a sbalzo - 1 vasca

Struttura in acciaio Inox - piano e vasca in acciaio inox AISI 304 - ripiano inferiore con rinforzo ad Omega - alzatina h 100 mm - piedini regolabili - piletta scarico e troppo pieno inclusi.

EN Single sink unit for built-in dishwasher

Stainless steel structure - top and bowl in stainless steel AISI 304 - bottom shelf with Omega reinforcement crossbar - h 100 mm backsplash - adjustable feet - drain and overflow drain included.

	 mm	 mm	 NET Kg	 GROSS Kg	 N.	
GDS127L1DW	1200 x 700 x 950(h)	1220 x 720 x 510(h)	22,3	32	1 SX/L - 500 x 400 x 300	680
GDS127R1DW	1200 x 700 x 950(h)	1220 x 720 x 510(h)	22,3	32	1 DX/R - 500 x 400 x 300	680
GDS147L1DW	1400 x 700 x 950(h)	1420 x 720 x 540(h)	26,9	39	1 SX/L - 600 x 500 x 300	730
GDS147R1DW	1400 x 700 x 950(h)	1420 x 720 x 540(h)	26,9	39	1 DX/R - 600 x 500 x 300	730

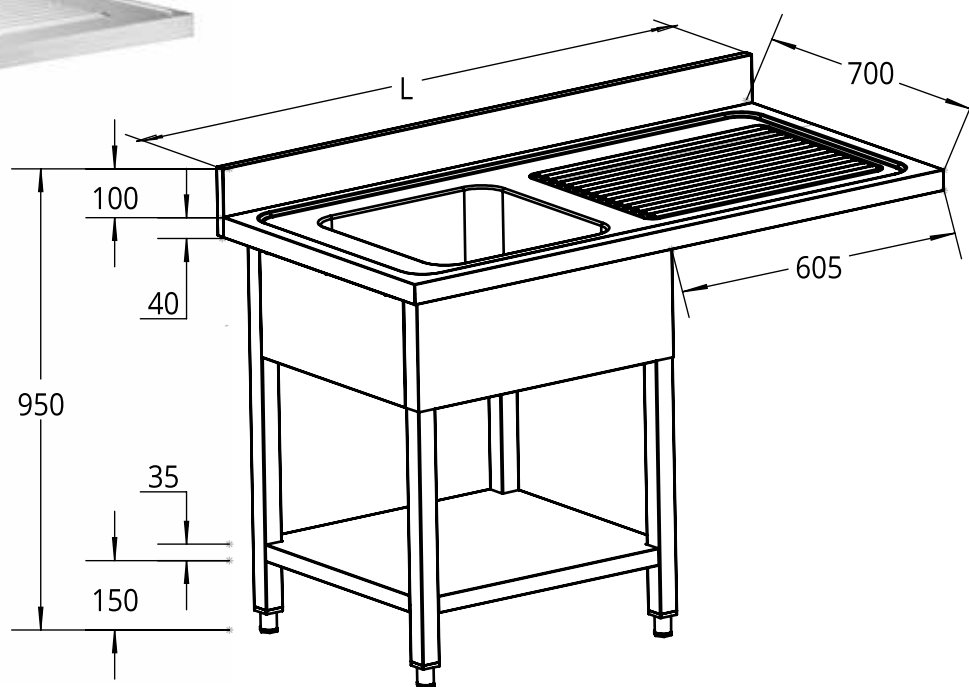







Lavelli a sbalzo - 1 vasca
Single sink unit for built-in dishwasher

IT Lavelli a sbalzo - 2 vasche

Struttura in acciaio Inox - piano e vasche in acciaio inox AISI 304 - ripiano inferiore con rinforzo ad Omega - alzatina h 100 mm - piedini regolabili - piletta scarico e troppo pieno inclusi.

EN Double sink unit for built-in dishwasher

Stainless steel structure - top and bowls in stainless steel AISI 304 - bottom shelf with Omega reinforcement crossbar - h 100 mm backsplash - adjustable feet - drain and overflow drain included.

	 mm	 mm	 NET Kg	 GROSS Kg	 N.	
GDS167L2DW	1600 x 700 x 950(h)	1620 x 720 x 540(h)	29,9	43	2 SX/L - 500 x 400 x 300	890
GDS167R2DW	1600 x 700 x 950(h)	1620 x 720 x 540(h)	29,9	43	2 DX/R - 500 x 400 x 300	890
GDS187L2DW	1800 x 700 x 950(h)	1820 x 720 x 540(h)	35	50	2 SX/L - 500 x 500 x 300	960
GDS187R2DW	1800 x 700 x 950(h)	1820 x 720 x 540(h)	35	50	2 DX/R - 500 x 500 x 300	960

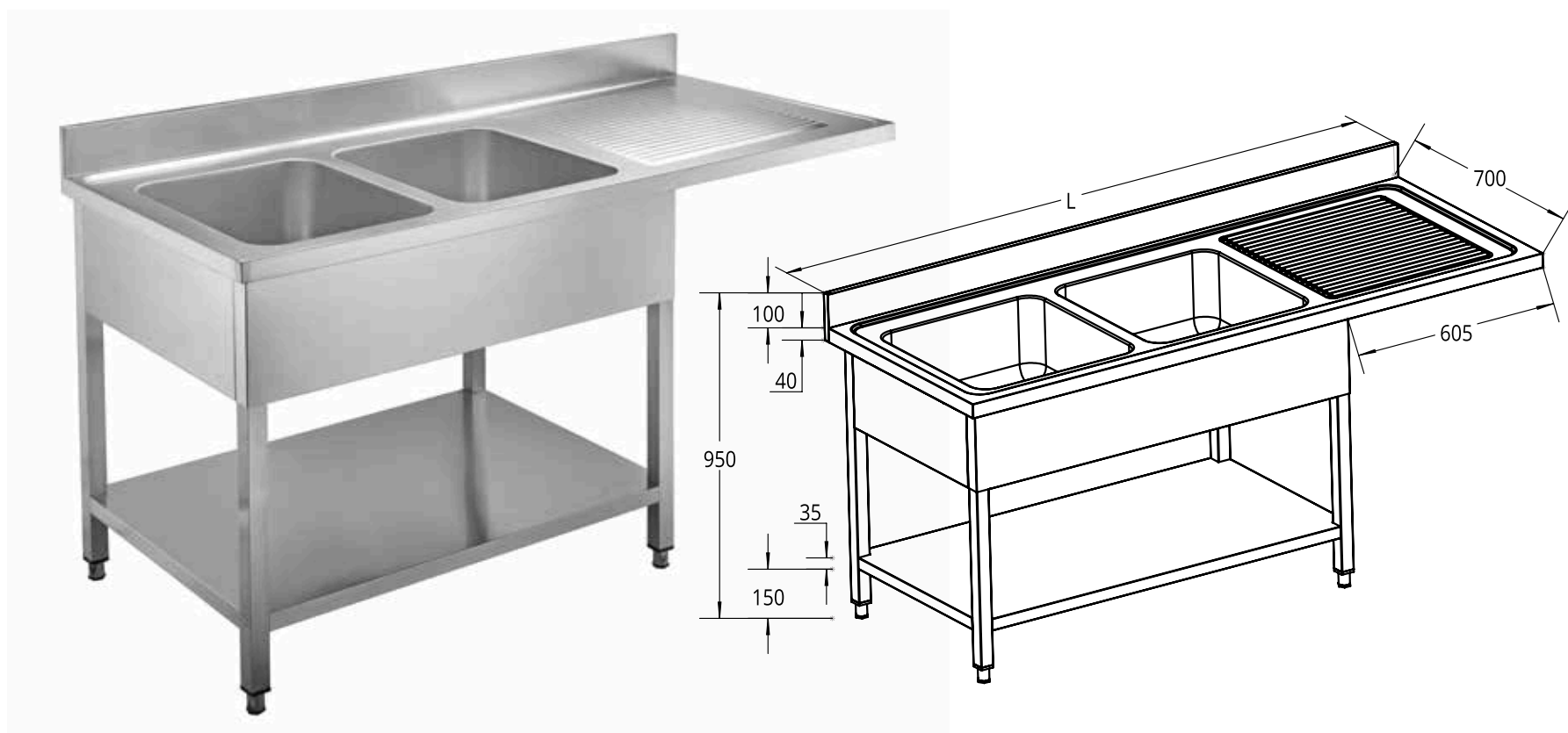









IT Lavelli aperti - 1 vasca

Con ripiano inferiore e sgocciolatoio - profondità 600 o 700 mm - struttura in acciaio Inox - piano e vasca in acciaio inox AISI 304 - ripiano inferiore con rinforzo ad Omega - alzatina h 100 mm - piedini regolabili - piletta scarico e troppo pieno inclusi.

EN One bowl sinks

With bottom shelf and drainer - depth 600 or 700 mm - stainless steel structure - top and Bowl in stainless steel AISI 304 - bottom shelf with Omega reinforcement crossbar - h 100 mm backsplash - adjustable feet - drain and overflow drain included.

		 mm	 mm	 Kg	 Kg	 N.	
 600	GD106BL1	1000 x 600 x 950(h)	1020 x 620 x 510(h)	22,1	30	1 SX/L - 400 x 400 x 300	595
	GD106BR1	1000 x 600 x 950(h)	1020 x 620 x 510(h)	22,1	30	1 DX/R - 400 x 400 x 300	595
	GD126BL1	1200 x 600 x 950(h)	1220 x 620 x 510(h)	25,2	35	1 SX/L - 500 x 400 x 300	715
	GD126BR1	1200 x 600 x 950(h)	1220 x 620 x 510(h)	25,2	35	1 DX/R - 500 x 400 x 300	715
	GD146BL1	1400 x 600 x 950(h)	1420 x 620 x 510(h)	27,7	38	1 SX/L - 500 x 400 x 300	780
	GD146BR1	1400 x 600 x 950(h)	1420 x 620 x 510(h)	27,7	38	1 DX/R - 500 x 400 x 300	780
 700	GD107BL1	1000 x 700 x 950(h)	1020 x 720 x 510(h)	24,2	34	1 SX/L - 500 x 400 x 300	705
	GD107BR1	1000 x 700 x 950(h)	1020 x 720 x 510(h)	24,2	34	1 DX/R - 500 x 400 x 300	705
	GD127BL1	1200 x 700 x 950(h)	1220 x 720 x 540(h)	28,5	37	1 SX/L - 500 x 500 x 300	745
	GD127BR1	1200 x 700 x 950(h)	1220 x 720 x 540(h)	28,5	37	1 DX/R - 500 x 500 x 300	745
	GD147BL1	1400 x 700 x 950(h)	1420 x 720 x 540(h)	31,7	44	1 SX/L - 600 x 500 x 300	800
	GD147BR1	1400 x 700 x 950(h)	1420 x 720 x 540(h)	31,7	44	1 DX/R - 600 x 500 x 300	800

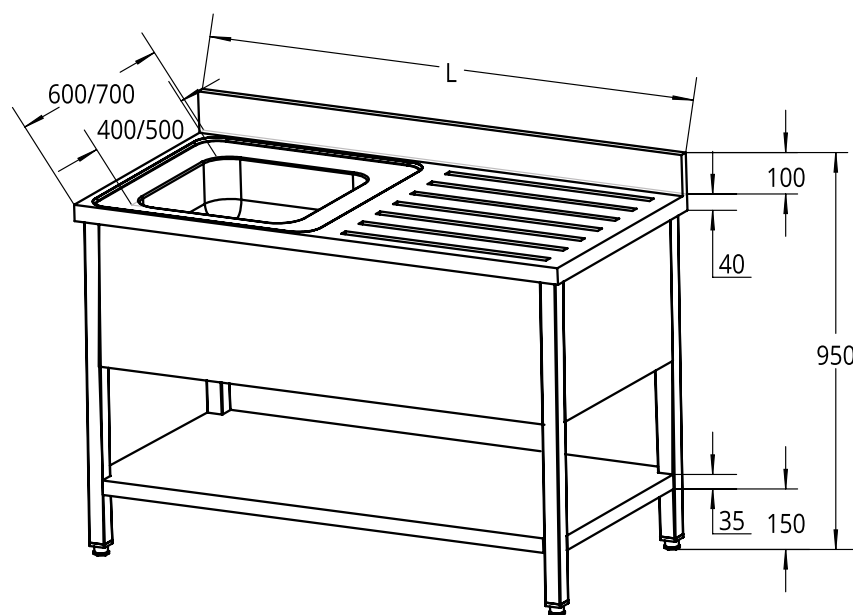









Lavelli aperti - 1 vasca
One bowl sinks

IT Lavelli aperti - 2 vasche

Con ripiano inferiore e sgocciolatoio - profondità 600 o 700 mm - struttura in acciaio Inox - piano e vasche in acciaio inox AISI 304 - ripiano inferiore con rinforzo ad Omega - alzatina h 100 mm - piedini regolabili - piletta scarico e troppo pieno inclusi.

EN Two bowls sinks

With bottom shelf and drainer - depth 600 or 700 mm - stainless steel structure - top and Bowls in stainless steel AISI 304 - bottom shelf with Omega reinforcement crossbar - h 100 mm backsplash - adjustable feet - drain and overflow drain included.

							
		mm	mm	Kg	Kg	N.	€
	GD166BL2	1600 x 600 x 950(h)	1620 x 620 x 510(h)	32,1	44	2 SX/L - 500 x 400 x 300	955
	GD166BR2	1600 x 600 x 950(h)	1620 x 620 x 510(h)	32,1	44	2 DX/R - 500 x 400 x 300	955
	GD186BL2	1800 x 600 x 950(h)	1820 x 620 x 510(h)	35,4	47	2 SX/L - 500 x 400 x 300	1.040
	GD186BR2	1800 x 600 x 950(h)	1820 x 620 x 510(h)	35,4	47	2 DX/R - 500 x 400 x 300	1.040
	GD206BM2	2000 x 600 x 950(h)	2020 x 620 x 510(h)	37,2	51	centrali / central 500 x 400 x 300	1.200
	GD167BL2	1600 x 700 x 950(h)	1620 x 720 x 510(h)	35,3	47	2 SX/L - 500 x 500 x 300	995
	GD167BR2	1600 x 700 x 950(h)	1620 x 720 x 510(h)	35,3	47	2 DX/R - 500 x 500 x 300	995
	GD187BL2	1800 x 700 x 950(h)	1820 x 720 x 540(h)	40,3	52	2 SX/L - 500 x 500 x 300	1.055
	GD187BR2	1800 x 700 x 950(h)	1820 x 720 x 540(h)	40,3	52	2 DX/R - 500 x 500 x 300	1.055
	GD207BM2	2000 x 700 x 950(h)	2020 x 720 x 540(h)	44,3	57	centrali / central 600 x 500 x 300	1.280

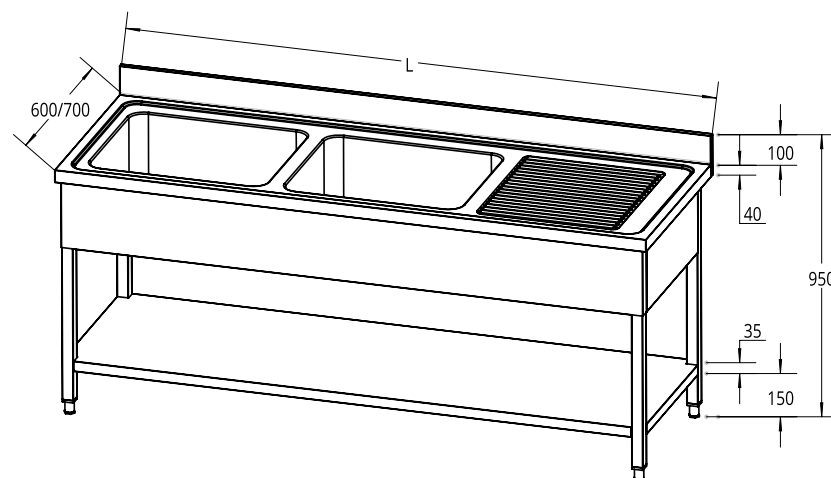
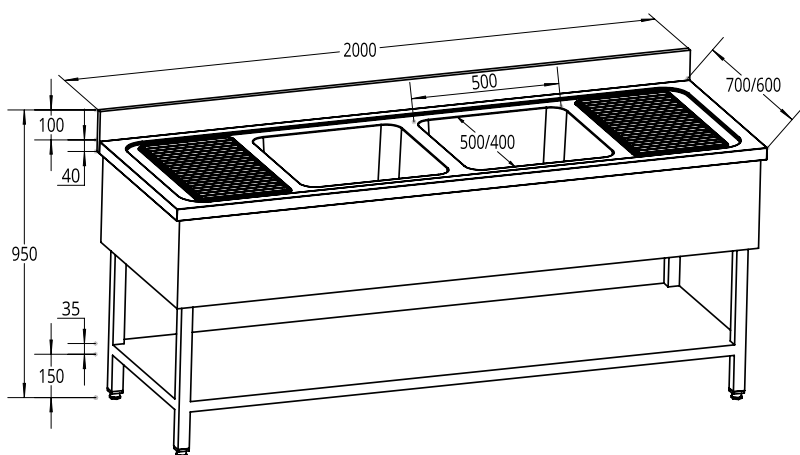







IT Lavelli aperti - 1 vasca

Senza sgocciolatoio con ripiano inferiore - profondità 700 mm - struttura in acciaio Inox - piano e vasca in acciaio inox AISI 304 - ripiano inferiore con rinforzo ad Omega - alzatina h 100 mm - piedini regolabili - piletta scarico e troppo pieno inclusi.

EN One bowl sinks

Without drainer - with bottom shelf - depth 700 mm - stainless steel structure - top and bowl in stainless steel AISI 304 - bottom shelf with Omega reinforcement crossbar - h 100 mm backsplash - adjustable feet - drain and overflow drain included.

	 mm	 mm	 NET Kg	 GROSS Kg	 N.	
GD67BM1A	600 x 700 x 950(h)	865 x 720 x 510(h)	16,9	25	500 x 400 x 300	575
GD77BM1A	700 x 700 x 950(h)	865 x 720 x 540(h)	19,4	28	500 x 600 x 300	585
GD87BM1A	800 x 700 x 950(h)	865 x 720 x 540(h)	21	30	500 x 600 x 300	605

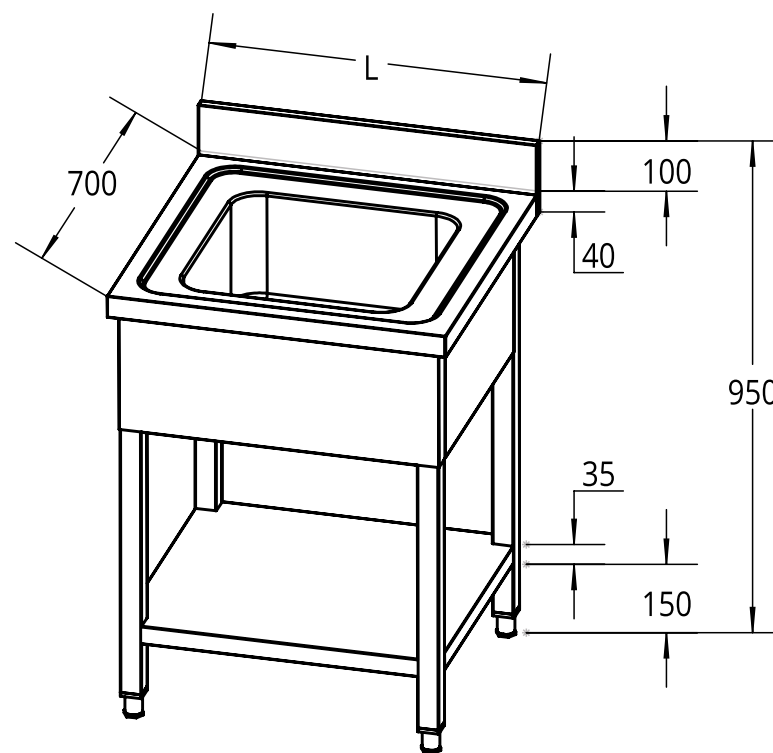







Lavelli aperti - 1 vasca
One bowl sinks

IT Lavelli aperti - 2 vasche

Senza sgocciolatoio con ripiano inferiore - profondità 700 mm - struttura in acciaio Inox - piano e vasca in acciaio inox AISI 304 - ripiano inferiore con rinforzo ad Omega - alzatina h 100 mm - piedini regolabili - piletta scarico e troppo pieno inclusi.

EN Two bowls sinks

Without drainer - with bottom shelf - depth 700 mm - stainless steel structure - top and bowl in stainless steel AISI 304 - bottom shelf with Omega reinforcement crossbar - h 100 mm backsplash - adjustable feet - drain and overflow drain included.

						
GD127BM2A	1200 x 700 x 950(h)	1220 x 720 x 540(h)	29,7 Kg	40 Kg	500 x 500 x 300	930

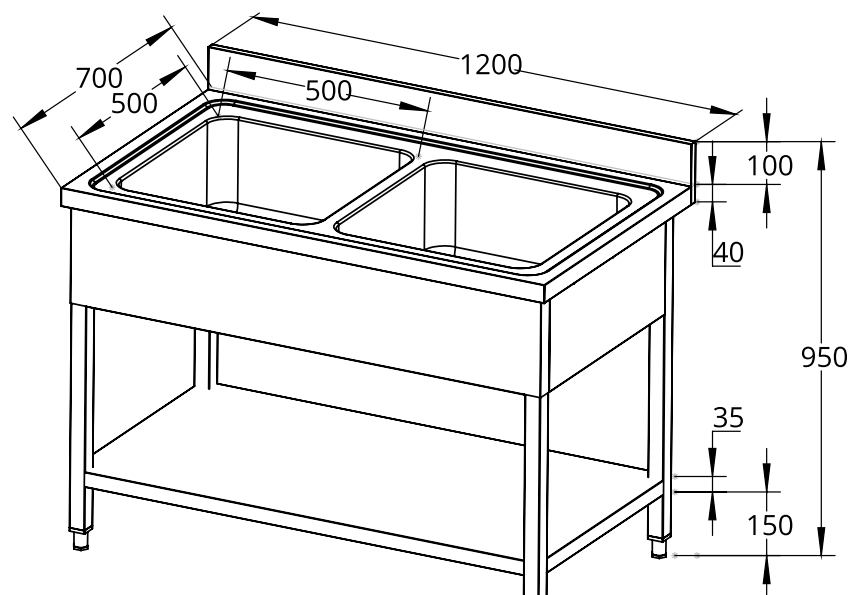







IT Lavelli armadiati 1 vasca con sgocciolatoio

Porte scorrevoli - profondità 700 mm - struttura in acciaio Inox - piano e vasca in acciaio inox AISI 304 - ripiano inferiore con rinforzo ad Omega - porte scorrevoli tamburate - alzatina h 100 mm - piedini regolabili - piletta scarico e troppo pieno inclusi.

EN One bowl Sinks with sliding doors and drainer

depth 700 mm - stainless steel structure - top and bowl in stainless steel AISI 304 - bottom shelf with Omega reinforcement crossbar - hollow core doors - h 100 mm backsplash - adjustable feet - drain and overflow drain included.

	 mm	 mm	 NET Kg	 GROSS Kg	 N.	
GDS107L1CS	1000 x 700 x 950(h)	1020 x 720 x 950(h)	39	50	1 SX/L - 500 x 400 x 300	895
GDS107R1CS	1000 x 700 x 950(h)	1020 x 720 x 950(h)	39	50	1 DX/R - 500 x 400 x 300	895
GDS127L1CS	1200 x 700 x 950(h)	1220 x 720 x 950(h)	44,7	57	1 SX/L - 500 x 500 x 300	935
GDS127R1CS	1200 x 700 x 950(h)	1220 x 720 x 950(h)	44,7	57	1 DX/R - 500 x 500 x 300	935
GDS147L1CS	1400 x 700 x 950(h)	1420 x 720 x 950(h)	50,5	65	1 SX/L - 600 x 500 x 300	1.000
GDS147R1CS	1400 x 700 x 950(h)	1420 x 720 x 950(h)	50,5	65	1 DX/R - 600 x 500 x 300	1.000

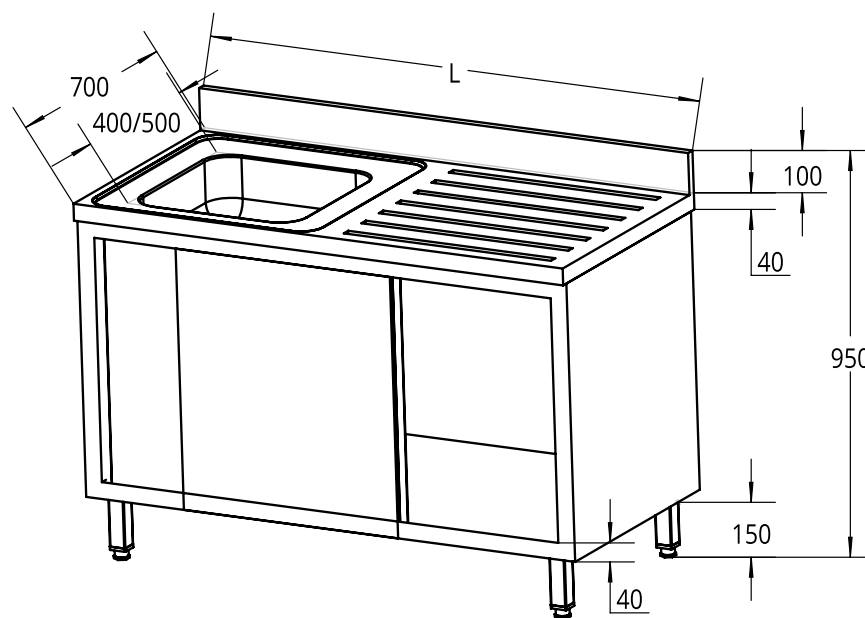







Lavelli armadiati - 1 vasca con sgocciolatoio
One bowl sinks - with sliding doors and drainer

IT Lavelli armadiati 2 vasche con sgocciolatoio

Porte scorrevoli - profondità 700 mm - struttura in acciaio Inox - piano e vasca in acciaio inox AISI 304 - ripiano inferiore con rinforzo ad Omega - porte scorrevoli tamburate - alzatina h 100 mm - piedini regolabili - piletta scarico e troppo pieno inclusi.

EN Two bowls Sinks with sliding doors and drainer

Depth 700 mm - stainless steel structure - top and bowl in stainless steel AISI 304 - bottom shelf with Omega reinforcement crossbar - hollow core doors - h 100 mm backsplash - adjustable feet - drain and overflow drain included.

	 mm	 mm	 NET Kg	 GROSS Kg	 N.	
GDS167L2CS	1600 x 700 x 950(h)	1620 x 720 x 950(h)	57	72	2 SX/L - 500 x 500 x 300	1.305
GDS167R2CS	1600 x 700 x 950(h)	1620 x 720 x 950(h)	57	72	2 DX/R - 500 x 500 x 300	1.305
GDS187L2CS	1800 x 700 x 950(h)	1820 x 720 x 950(h)	63	79	2 SX/L - 500 x 500 x 300	1.370
GDS187R2CS	1800 x 700 x 950(h)	1820 x 720 x 950(h)	63	79	2 DX/R - 500 x 500 x 300	1.370

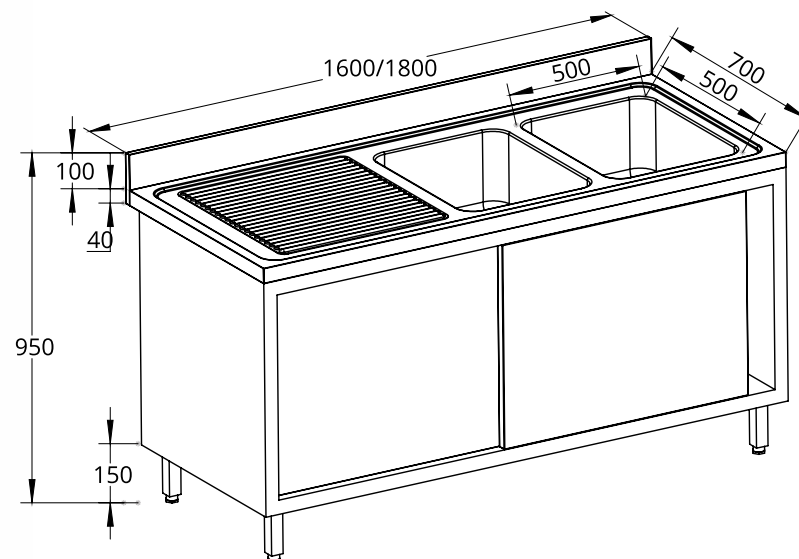







IT Lavello armadiato
2 vasche centrali con sgocciolatoio

Porte scorrevoli - profondità 700 mm - struttura in acciaio Inox - piano e vasca in acciaio inox AISI 304 - ripiano inferiore con rinforzo ad Omega - porte scorrevoli tamburate - alzatina h 100 mm - piedini regolabili - piletta scarico e troppo pieno inclusi.

EN Two central bowls sink
with drainer

With sliding doors depth 700 mm - stainless steel structure - top and bowl in stainless steel AISI 304 - bottom shelf with Omega reinforcement crossbar - hollow core doors - h 100 mm backsplash - adjustable feet - drain and overflow drain included.

						
GDS207M2CS	2000 x 700 x 950(h)	2020 x 720 x 950(h)	67,3 Kg	85 Kg	centrali/central 500 x 500 x 300	1.475

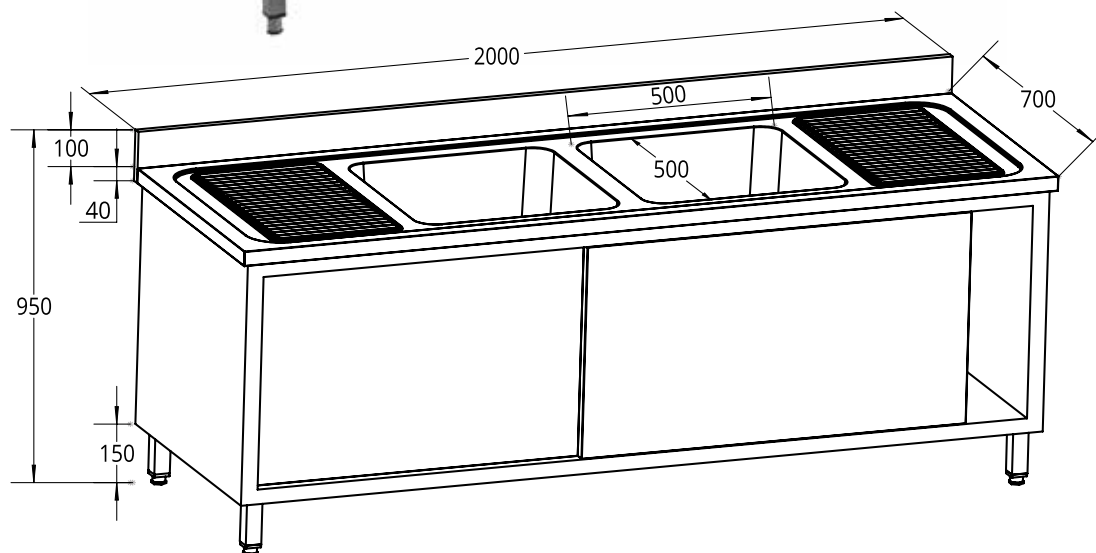

Lavello armadiato - 2 vasche centrali con sgocciolatoio
Two central bowls sink - with drainer

GDO120M

IT Gruppo doccia con miscelatore monoforo h 1200 mm
Con manopole multigiro

EN Pre-rinse unit with single hole mixer h 1200 mm
Multiple turn knobs.

GDO120MR





IT Gruppo doccia con miscelatore monoforo h 1200 mm - con manopole multigiro e rubinetto.

EN Pre-rinse unit with single hole mixer h 1200 mm - multiple turn knobs and service tap.

GDO70MR

IT Gruppo doccia con miscelatore monoforo h 700 mm - con manopole multigiro e rubinetto.

EN Pre-rinse unit with single hole mixer h 700 mm - multiple turn knobs and service tap.

	 mm	 Kg	 Kg	
GDO120M	800 x 300 x 100(h)	4,1	4,9	295
GDO120MR	800 x 300 x 100(h)	4,7	5,5	375
GDO70MR	800 x 300 x 100(h)	4	4,8	370



GDO120M



GDO120MR

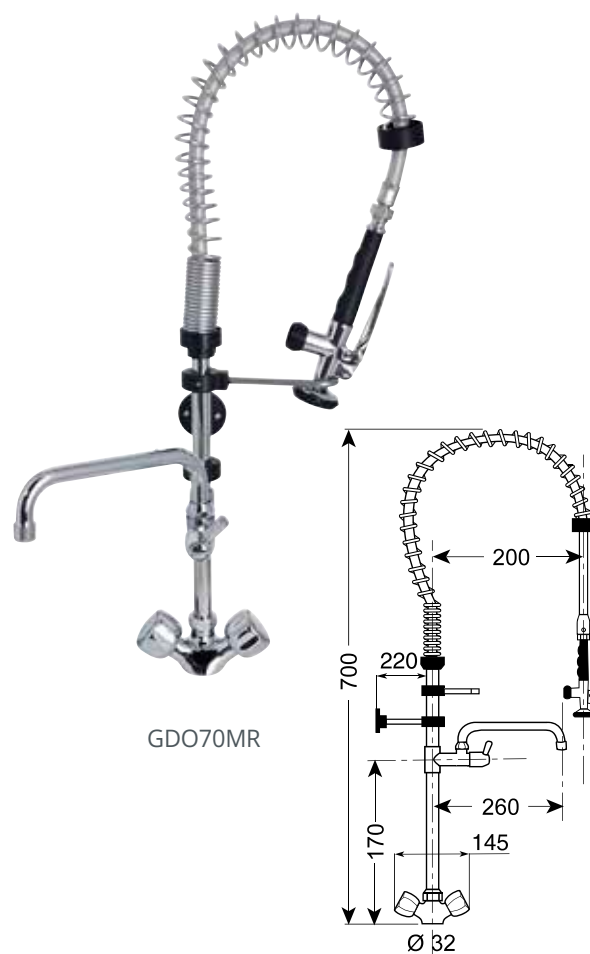

GDO70MR

GDO120L

IT Gruppo doccia con miscelatore monoforo h 1200 mm - con leva clinica.

EN Pre-rinse unit with single hole mixer h 1200 mm - elbow lever.

GDO120LR





IT Gruppo doccia con miscelatore monoforo h 1200 mm - con leva clinica e rubinetto.

EN Pre-rinse unit with single hole mixer h 1200 mm - elbow lever and service tap.

GDO70LR

IT Gruppo doccia con miscelatore monoforo h 700 mm - con leva clinica e rubinetto.

EN Pre-rinse unit with single hole mixer h 700 mm - elbow lever and service tap.

	 mm	 Kg	 Kg	
GDO120L	800 x 300 x 100(h)	4,3	5,1	335
GDO120LR	800 x 300 x 100(h)	4,8	5,6	405
GDO70LR	800 x 300 x 100(h)	4,1	4,9	400

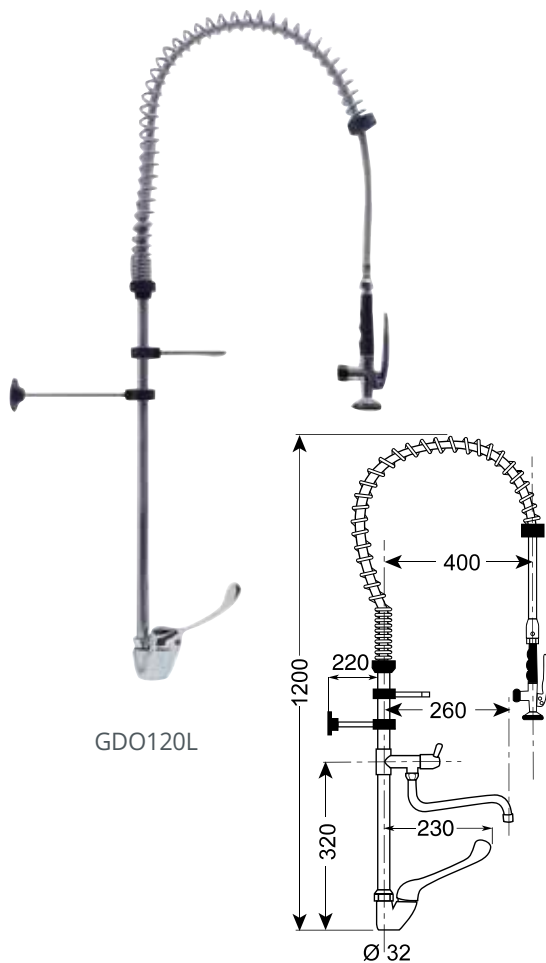

GDO120L

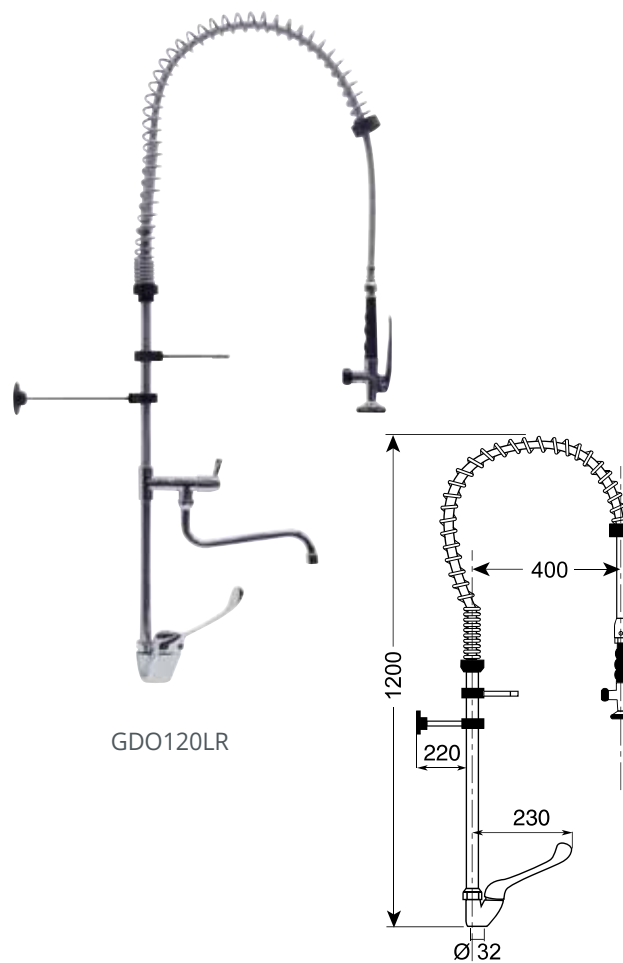

GDO120LR

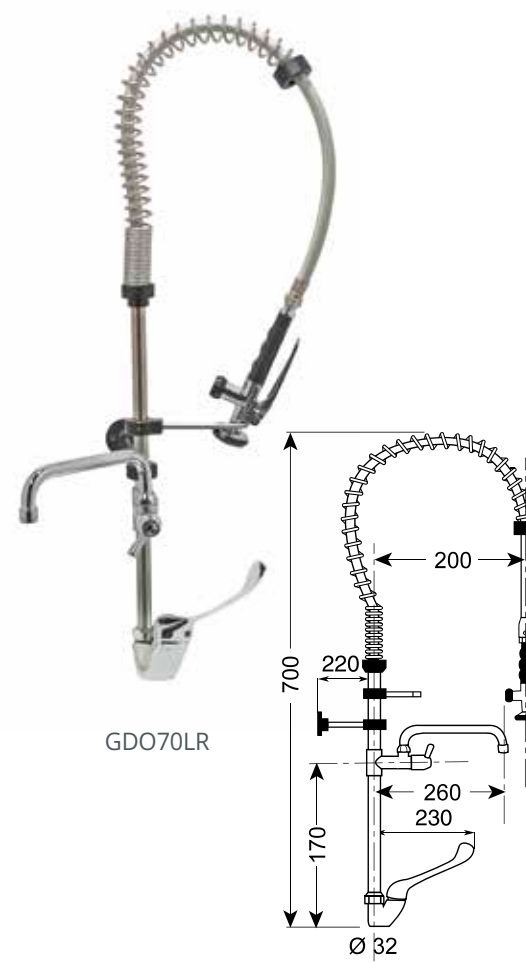





GDO70LR

MIS22LC

IT Miscelatore monoforo con leva clinica - L 220 mm - uscita tubo bassa.

EN Single hole mixer with elbow lever L 220 mm - Lower spout.

	 mm	 Kg	 Kg	
MIS22LC	370 x 140 x 70(h)	1	1,1	100
MIS22LP	370 x 140 x 70(h)	0,95	1,05	95

MIS22LP

IT Miscelatore monoforo con leva clinica in plastica nera - L 220 mm - uscita tubo bassa.





EN Single hole mixer with black lever L 220 mm - Lower spout.



MISDOES

IT Miscelatore monoforo - leva e doccetta estraibile.

EN Single hole mixer - pull out hose, elbow lever.

	 mm	 Kg	 Kg	
MISDOES	340 x 180 x 70(h)	1,6	1,7	150
RUB30M	420 x 170 x 90(h)	1	1,1	85

RUB30M

IT Rubinetto monoforo con manopole multigiro L 300 mm.

EN Single hole mixer with multiple turn knobs, L 300 mm.



MISDOES

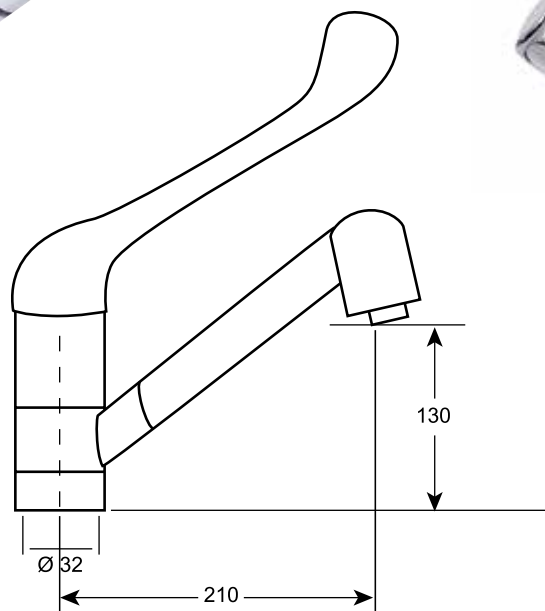

RUB30M

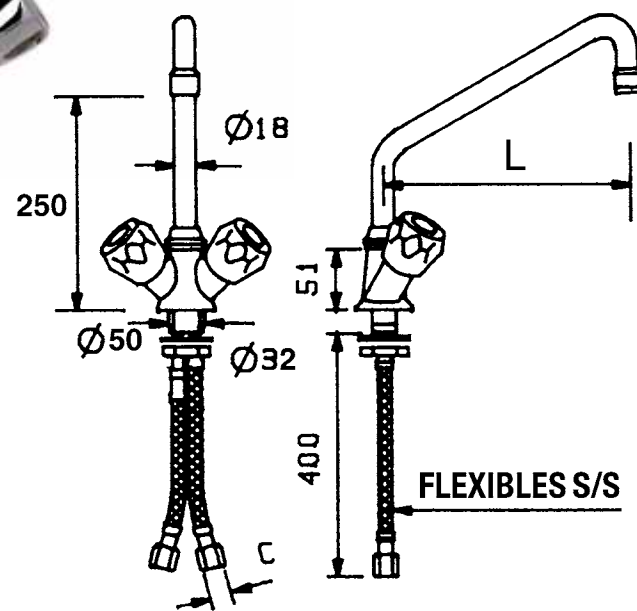





Miscelatore monoforo
Single hole mixer

PEDA1MON

IT Rubinetto a pedale a terra monoacqua
Blocco unico ad un pedale (1 entrata - 1 uscita).

EN Foot operated tap cold water, floor fixing,
single lever (1 inlet - 1 outlet).

	 mm	 Kg	 Kg	
PEDA1MON	290 x 100 x 100(h)	1	1,1	120
PEDA1MIS	300 x 130 x 110(h)	1,5	1,6	140

PEDA1MIS

IT Rubinetto a pedale a terra con miscelatore - fissaggio a - blocco
unico ad un pedale (2 entrate - acqua fredda/calda - 1 uscita acqua
miscelata).

EN Mixer foot operated tap, floor fixing,
single lever (2 water inlet - cold/hot - 1 mixed water outlet).



PEDA1MON

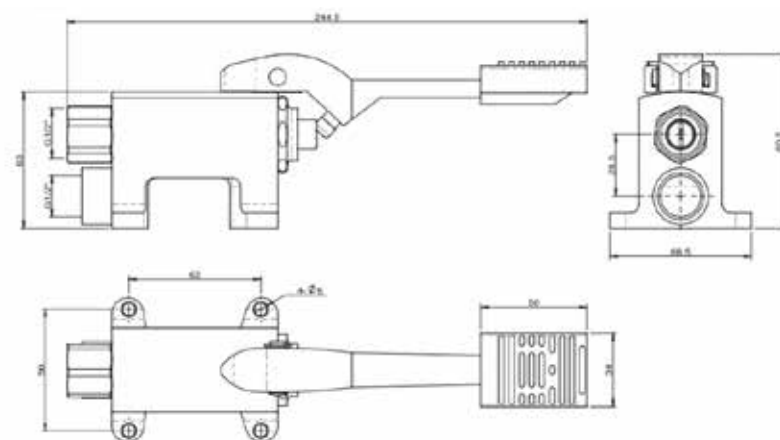

PEDA1MIS

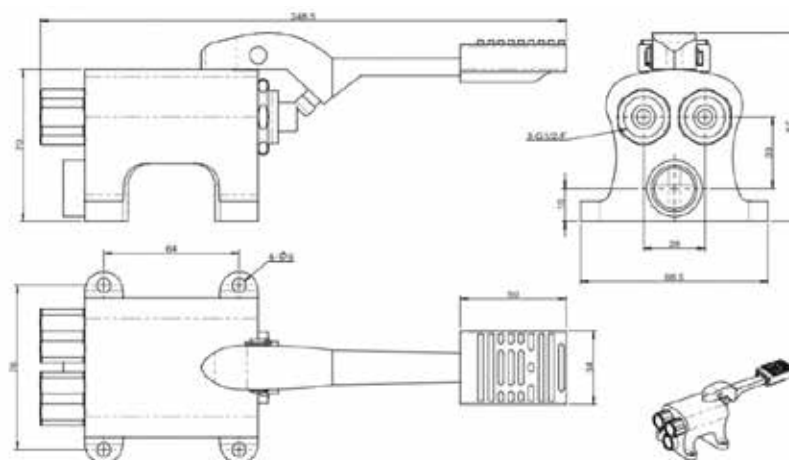

PEDA2





IT Rubinetto a doppio pedale - fissaggio a terra - blocco unico.

EN Mixer foot operated tap, floor fixing, two levers.

BOERO20 - BOERO30

IT Bocca di erogazione orientabile completa di base ø 18 mm.

EN Swivelling spout with base ø 18 mm.

	 mm	 Kg	 Kg	
PEDA2	290 x 150 x 100(h)	1,7	1,8	190
BOERO20	busta pluriball plastic bag	0,23	0,23	26
BOERO30	busta pluriball plastic bag	0,28	0,28	30



PEDA2

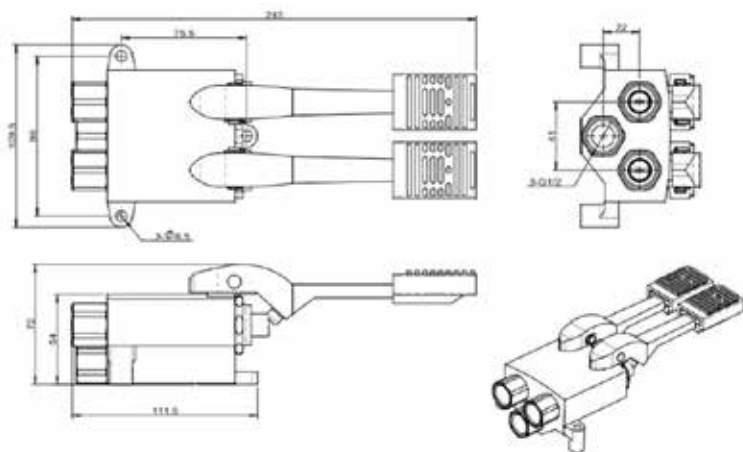

BOERO20
BOERO30

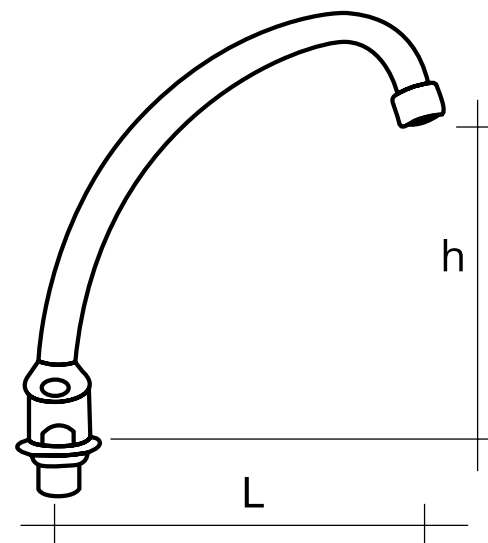

1/2" GAS

BOERO20 = L 200 mm - h = 180 mm

BOERO30 = L 300 mm - h = 225 mm

Rubineti per lavamani
Taps for hand washers